

ALL SOULS OF FIRE

PRICE LIST

2026

STOVES

FIREPLACES

INSERTS

(PELLET/WOOD)

PELLET BOILERS

ACCESSORIES

PELLET STOVES_Air/Comfort Air Maestro

17

PELLET STOVES_Air/Comfort Air Easy

61

PELLET STOVES_Hydro Maestro

77

PELLET_Fireplaces and inserts

89

WOOD_Fireplaces and inserts

101

PELLET BOILERS

123

PELLET_Accessories

137

WOOD_Accessories

145

TECHNOLOGIES



EXCLUDABLE VENTILATION

With the 'No Air' function, pellet stoves can significantly reduce the effect of forced ventilation, and in some models even eliminate it completely. This technology makes the stove quieter and more comfortable.



IGNITION IN 3 MINUTES

Product equipped with ceramic spark plug ensuring ignition times reduced by 40%.



WEEKLY ASH EMPTYING

The high capacity of the ash drawer allows the stove to be used for a week without emptying (average power consumption, 8 hours/day operation).



STRUCTURE COMPLETELY SEALED

Products built with Oyster technology do not consume oxygen by taking all the air from the environment outside so therefore can be placed inside every home properly insulated and within passive houses.



COAXIAL SMOKE DUCT

Coaxial smoke duct to evacuate the smoke and also to draw in the combustion air.



BRUSHLESS

Thanks to advanced technology, the new brushless gear motor guarantees high sound comfort (almost no noise) and substantial energy savings (consumption 90% lower compared to traditional motors). Used in the pellet loading system of all stoves.



DUAL CONNECTIVITY

For Maestro+ products, it is possible to control the stove from a smartphone over a home Internet network (Wi-Fi router) or through a Bluetooth connection (BLE Bluetooth Low Energy). Specifically, the connection via smartphone/stove remote control is controlled via BLE without using the home internet connection.



KIT WI-FI EASY CONNECT

For remote connection via the app. To be installed on the back of the stove, self-powered. Compatible with a 2.4 GHz frequency Wi-Fi router.



1 / Automatic self-cleaning brazier with comb mechanism for a more effective cleaning

2 / Dedicated brushless engine

3 / Utmost combustion efficiency thanks to the electronics that defines the mechanical cleaning in regular cycles or in case of blockages

4 / Availability both on water and high power air versions (14 kW)

5 / Ash pan allowing the emptying on a weekly basis or beyond

MANY SOLUTIONS TO TAKE ADVANTAGE OF ALL THE SPACE AVAILABLE IN YOUR HOME



CONFINED SPACES

Thanks to a very limited depth, these products are particularly suitable in small rooms or hallways.



USE OF OLD FIREBOXES

These products are designed to be able to use old fireboxes that do not work and/or do not heat, thanks to a limited height (stoves) and the possibility of being incorporated (chimneys).



USE OF EXISTING FLUES

Thanks to the presence of an upper flue outlet, these stoves can take advantage of the existing flues, thereby optimising the living space and reducing installation costs.

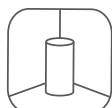

CORNER SOLUTIONS

Stoves designed to take advantage of the corners in a home, which are generally used very little.



WALL-MOUNTED INSTALLATIONS

This is the classic solution: installed in front of a wall (stove) or inserted into the wall (chimney), these products blend in perfectly with the architecture of the room.



SEPARATION OF ROOM

Products that have two or three exposed sides, which allow for a view of the fire from separate rooms, thereby optimising the living space.

COMBUSTION CONTROL SYSTEMS

maestro+

MAESTRO+, THE MOST ADVANCED USER EXPERIENCE

- 1 / DUAL CONNECTION (WI-FI AND BLUETOOTH) INCLUDED.**
Everything you need to use the stove from your smartphone is already included, either at home or remotely Maestro+, without additional kits.
- 2 / PERFECT FLAME**
The combustion with Maestro is optimal, it generates less ash and leaves the glass clean. This results in lower consumptions, lower emissions and much less frequent cleanings.
- 3 / MORE USER OPTIONS**
Maestro stoves adapt to your style of use. When not at home you can use your smartphone (with stove connected via home Wi-Fi router), at home you can control the stove via the concealed control panel, smartphone (via Bluetooth) or remote control (optional).
- 4 / AUTOMATIC REMOTE FIRMWARE UPDATE**
(for WI-FI connected stoves).
- 5 / REMOTE DIAGNOSTICS AND ASSISTANCE**
(except operations that require a technician to be physically present).



MAESTRO+, STOVE CONTROL MODES

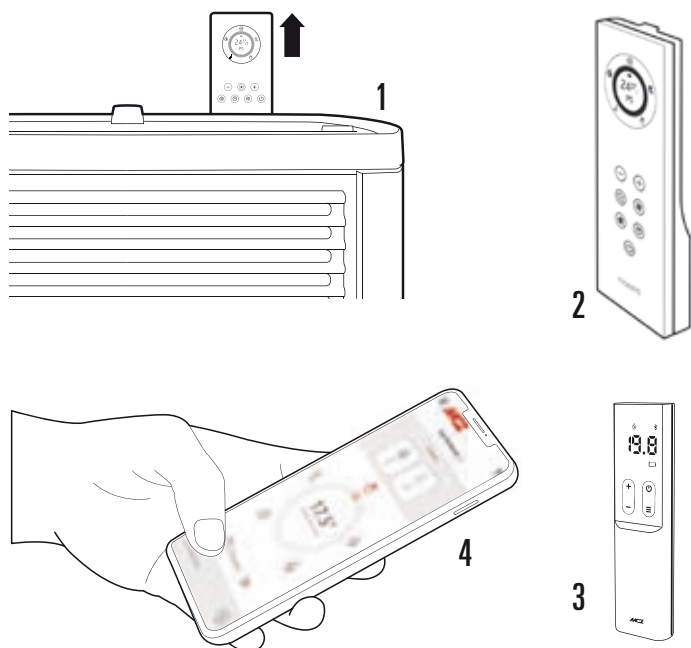

- 1 / DIGITAL PANEL**
If you are used to a more traditional style of use, all the features of the Maestro App are also available in a new control panel (standard) that integrates the ordinary and extraordinary features (emergency panel).
- 2 / FREESTANDING REMOTE CONTROL**
Remote control with ambient thermostat for room temperature control, always visible thanks to the e-ink display (optional).
- 3 / LIGHT REMOTE CONTROL**
Maestro+ thermostatic remote control unit. Small dimensions and stove control with only two buttons. 3 preset modes: manual, automatic, comfort. Bluetooth connection (optional).
- 4 / APP**
For remote stove control at home and away from home, today even easier to use.



WI-FI CONNECTIVITY FOR REMOTE CONTROL WITH "EASY CONNECT" DEDICATED APP

Exclusively for EASY LINE products, our range of the most user-friendly products.

TECHNOLOGIES

core

Core is the new firebox with patented technology that has shaken up the pellet combustion world: a wide natural flame similar to wood-fired products, one of the category's lowest emission levels, and pleasing to the eye either on or off. The CORE technology is protected by 3 patents.

Designed by the very flame, the firebox no longer has all the technical parts exposed. The combustion of the gases produced by pellets is harnessed to slow down the flame and provide a unique view of the fire.



Clean glazing for long periods of time thanks to the extremely low level of emissions

Firebox with AISI 304 stainless steel core and cast iron shell

Gasification and post-combustion in several points of the combustion chamber

With its self-cleaning brazier, no brazier cleaning is required



SILENCE IS A LUXURY, TREAT YOURSELF

The Comfort and Overnight modes make operation even quieter.



Thanks to its very low smoke extraction speed, ventilation is almost imperceptible.



Available for the models:
Eiko, Mako, Curve, Mood, Feel, Ego Air e
Comfort Air Matic, Musa/Club/Suite Air
Matic, Comfort Air Matic 12 e Comfort Air
Matic 14 kW

MAKO

ONE OF THE CATEGORY'S LOWEST EMISSION LEVELS

Performance is entirely met at all operating power levels.

Core's emission levels fall widely within the strictest European limits.



COMBUSTION CONTROL SYSTEMS



DUCTED AIR



DIFFUSER POSITIONABLE UP TO 8 METRES, FREELY

Comfort Air® can effectively carry the warm air (80°C) into other rooms up to a maximum distance of 8 meters. Unlike traditional systems in which the jets must be positioned at the top, Comfort Air® allows the jets to be freely positioned.



EASE OF INSTALLATION AND MAINTENANCE

With a significantly smaller diameter than other models on the market (60 mm and 100 mm), Comfort Air® ensures easier installation of the funnel into the wall, consequently limiting the necessary masonry works, which often take time and are very invasive, and making the fans easier to maintain.

TOTAL AIR DISTRIBUTION CONTROL

Fitting an electronic control unit, Comfort Air® can control up to 2/3 air flows (in closed fireplaces) to distribute heat and convey warm air into various rooms.

THE FIRST DESIGN DIFFUSERS

Comfort Air® is fitted with air distribution outlets that, for the first time, offer a true design piece. These outlets are ideal for integration into any furnishing, with their minimalist design and exclusive light and aromatherapy function that makes them unique on the market.



FORCED VENTILATION

A TRULY COMPLETE RANGE

To satisfy all requirements, in terms of power and operative functions.



WATER





















HOT RADIATORS FAST

Thanks to low thermal inertia, Hydro pellet stoves, once on, are able to heat your domestic radiators in just a few minutes (for some models there are also kits for connection to the hot water system).





















MAXIMUM HEAT EXCHANGE

About 90% of power rendered overall by the stove is transferred to the water guaranteeing excellent performance who those choosing radiators for domestic heating.

Pellet stoves / Technologies

	Eiko Natural Matic 6 Core Free	Eiko Natural Matic 6 Core Free UP	Mako C.air Matic 8 Core R	Tecla Air 6 R	Ego Core Air Matic 8	Ego Core Comfort Air Matic 10	Ego Air 8	Ego Air UP 8	Ego Air XUP 8	Ego Hydro Matic 8	Ego Hydro Matic 12	Star Air 8	Star Air UP 8	Star Comfort Air 10	Star Comfort Air UP 10	Musa Core Air Matic 10	Musa Air 10
	●	●															
				●	●	●	●	●	●			●	●	●	●	●	●
			●			●								●	●		
																	
										●	●						
	●	●	●	●	●	●	●	●	●			●	●	●	●	●	●
	●	●	●	●	●	●	●	●	●	●	●	●	●	●	●	●	●
			●	●	●	●	●	●	●			●	●	●	●	●	●
	●	●	●	●	●	●	●	●	●	●	●	●	●	●	●	●	●
	●	●	●		●	●				●	●					●	
	●	●			●	●	●	●	●	●	●	●	●	●	●	●	●
								●					●		●		
									●								
																	
	●	●	●	●	●	●	●	●	●	●	●	●	●	●	●	●	●
	●	●	●	●	●	●	●	●	●	●	●	●	●	●	●	●	●
	○	○	○		○	○	○	○	○	○	○	○	○	○	○	○	○
	●	●		●	●	●	●	●	●	●	●	●	●	●	●	●	●
																	
	●	●		●	●	●	●	●	●	●	●	●	●	●	●	●	●
	●	●			●	●										●	
	p.19	p.19	p.20	p.22	p.25	p.25	p.26	p.27	p.27	p.79	p.79	p.30	p.31	p.30	p.31	p.33	p.34

Pellet stoves / Technologies

	Mako Core Comfort Air 8	Feel Comfort Air Matic 12 Core	Feel Comfort Air Matic 12 Core Up	Aki Hydro Matic 18	Aki Hydro Matic 24	Ray Comfort Air 8	Ray Comfort Air 8 UP	Ray Comfort Air 8 XUP	Decò Air 8	Cute Air 8	Tecla Air 6
 natural											
 air	●					●	●	●	●	●	●
 comfort air	●	●	●			●	●	●			
 comfort air											
 hydro				●	●						
 oyster	●	●	●			●	●	●	●	●	●
 quick start	●	●	●	●	●	●	●	●	●	●	●
 no air	●										●
 brush less	●	●	●	●	●	●	●	●	●	●	●
 matic	●	●	●	●	●						
 calendar	●	●	●	●	●	●	●	●	●	●	
 remote			●				●		●	●	
 pot								●			
 kit wi-fi											
 wi-fi	●	●	●	●	●	●	●	●	●	●	●
 tablet	●	●	●	●	●	●	●	●	●	●	●
 tablet	○	○	○	○	○	○	○	○	○	○	○
 tablet	●	●	●	●	●	●	●	●	●	●	●
 maestro											
 maestro+	●	●	●	●	●	●	●	●	●	●	●
 core	●	●	●								
	p.20	p.48	p.48	p.84	p.84	p.50	p.50	p.50	p.46	p.47	p.22

Easy

Fireplaces

	Alea Air 7	Alea Air 7 XUP	Raam Air 8	Raam Air 8 UP	Ghea Air 6	Ghea XUP Air 6	Mida Air 8	Mida XUP Air 8	Teia Comfort Air 10	Teia UP Comfort Air 10	May Air 7	Hera XUP Air 7		Vivo 90 Comfort Air 9	Vivo 90 Comfort Air 11	Vivo 90 Hydro 16	Vivo 90 Hydro 24	Qbox 60	Qbox 70	
	●	●	●	●	●	●	●	●	●	●	●	●							●	●
			●	●					●	●										
														●	±					
	●	●	●	●	●	●	●	●	●	●	●	●		●	●	●	●		●	●
			●	●					●	●				●	●	●	●	●	●	●
	●	●			●	●	●	●	●	●	●	●								
														●	●	●	●	●	●	●
			●	●	●	●	●	●	●	●	●	●		●	●	●	●			
		●		●		●	●	●		●		●								
	●	●										●								
	○	○	○	○	○	○	○	○	○	○	○	○								
														●	●	●	●	●	●	●
	●	●	●	●	●	●	●	●	●	●	●	●		○	○	○	○	○	○	○
	○	○	○	○	○	○	○	○	○	○	○	○		○	○	○	○	○	○	○
	○	○	○	○	○	○	○	○	○	○	○	○		●	●	●	●	●	●	●
														●	●	●	●			
																		●	●	
p.71																				
p.71																				
p.72																				
p.72																				
p.62																				
p.62																				
p.65																				
p.65																				
p.66																				
p.66																				
p.69																				
p.74																				
p.90																				
p.92																				
p.99																				
p.99																				
p.95																				
p.97																				

PRODUCTS OVERVIEW > PELLET



CORE	19	20	-	-	25	-	33	38
AIR	-	-	22	23	25>27	30>31	33>35	38>40
COMFORT AIR	-	20	-	-	25>27	30>31	33>35	38>40
HYDRO	-	-	-	-	90	92	93	94
WOOD	-	-	-	-	-	-	-	-



CORE	-	-	-	-	-	-	-	-
AIR	-	74	77	-	81	83	-	86
COMFORT AIR	69	-	-	78	-	-	84	-
HYDRO	-	-	-	-	-	-	-	-
WOOD	-	-	-	-	-	-	-	-



43	-	-	48	58	61	-	-	-
43>45	46	47	-	58	-	62>63	65	-
43>45	-	-	48	-	61	-	-	66
95	-	-	-	-	-	-	-	-
-	-	-	-	-	-	-	-	-



-	-	-	-	-	-	-	-
-	-	-	-	-	116	117	-
-	-	-	110>111	112>113	-	-	-
98	101	105	-	-	-	-	119
-	-	-	-	-	-	-	-

PRODUCTS OVERVIEW > WOOD

DX/SX > RH/LH > RE./LI. > Droite/Gauche



CORE	-	-	-	-	-	-	-	-
AIR	-	-	-	-	-	-	-	-
COMFORT AIR	-	-	-	-	-	-	-	-
HYDRO	-	-	-	-	-	-	-	-
WOOD	122	123	124	125	126	127	128	129



CORE	-	-	-	-	-	-	-	-
AIR	-	-	-	-	-	-	-	-
COMFORT AIR	-	-	-	-	-	-	-	-
HYDRO	-	-	-	-	-	-	-	-
WOOD	130	131	133	133	134	135	136	137



CORE	-	-
AIR	-	-
COMFORT AIR	-	-
HYDRO	-	-
WOOD	138	140

CHOOSE YOUR SHAPE

SQUARE

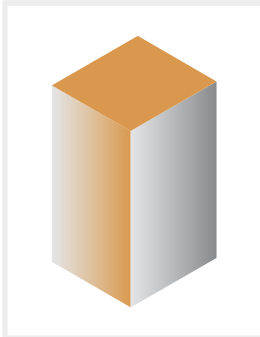

- AIR
- 19 Eiko
- 22 Tecla
- 26 Ego
- 30 Star
- 34 Musa
- 39 Club
- 44 Suite
- 65 Mida
- 62 Ghea
- 69 May

- COMFORT AIR
- 20 Mako
- 25 Ego
- 30 Star
- 33 Musa
- 40 Club
- 45 Suite
- 66 Teia

- HYDRO
- 79 Ego
- 81 Musa
- 82 Club
- 83 Suite

- CORE
- 19 Eiko
- 20 Mako
- 25 Ego
- 33 Musa
- 38 Club
- 43 Suite
- 48 Feel

SLIM

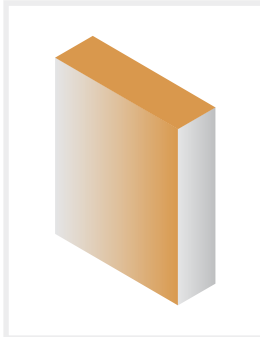

- AIR
- 71 Alea

- COMFORT AIR
- 48 Feel
- 50 Ray
- 72 Raam

- HYDRO
- 84 Aki

- CORE
- 48 Feel

ROUND

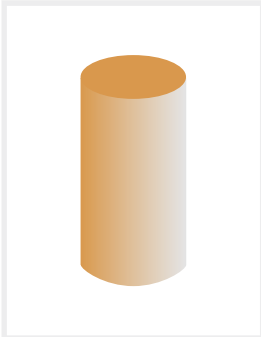

- AIR
- 56 Halo
- 59 Loop
- 74 Hera

- COMFORT AIR
- 52 Curve
- 55 Mood

- HYDRO
- 87 Pad

- CORE
- 52 Curve new
- 55 Mood new

MINI

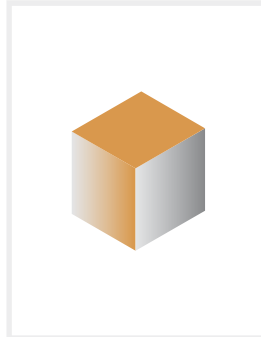

- AIR
- 46 Decò
- 47 Cute

INSERTS

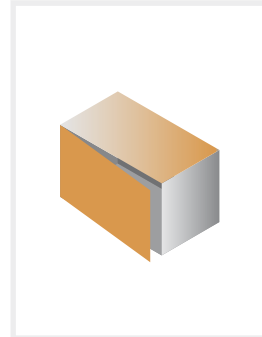

- AIR
- 95 Qbox 60
- 97 Qbox70

- COMFORT AIR
- 90 Vivo 90

- HYDRO
- 99 Vivo 90 Hydro

PELLET

PELLET STOVES_Air/Comfort Air Maestro

- 38 CLUB > Air Matic, Air, Comfort Air, Core
- 52 CURVE CORE > Core, Air Matic
- 47 CUTE > Air
- 46 DECÒ > Air
- 25 EGO > Core, Air, Comfort Air, Matic
- 19 EIKO > Core, Natural, Matic
- 48 FEEL > Core, Comfort Air, Matic
- 56 HALO > Air
- 58 LOOP > Air
- 20 MAKO > Comfort Air
- 54 MOOD > Core, Comfort Air, Matic
- 32 MUSA > Core, Air, Comfort Air, Matic
- 50 RAY > Comfort Air
- 30 STAR > Air, Comfort Air
- 42 SUITE > Core, Air, Comfort Air, Matic
- 22 TECLA > Air

EIKO





	CODE	£
EIKO NATURAL MATIC 6 CORE R	7122083	2832.06
EIKO NATURAL MATIC 6 CORE UP	7124005	2926.31

	303 Black metal	6923001 194.04
	Custom (Grès with a maximum thickness of 3.5 mm)	6923002 200.55
	251 Materia Corten	6923003 374.22
	252 Materia Tortora	6923004 374.22
	253 Materia Piombo	6923005 374.22

	Maestro smartphone app (free download)	
	Control panel "Lift" that integrates the ordinary functionalities with those of the emergency panel	
	Temperature probe	
	Pellet level sensor	

EIKO NATURAL MATIC 6 CORE R NEW

Model: EIKO NATURALMATIC 6 M1 CORE

POWER kW					
6	92	8	126-129	0,7-1,4	15

	Maestro+ FREESTANDING thermostatic remote control Remote control with ambient thermostat and humidity sensor for room temperature control, always visible thanks to the e-ink display	4022002 269.85
	LIGHT Maestro+ thermostatic remote control unit Small dimensions and stove control with only two buttons. 3 preset modes: manual, automatic, comfort. Bluetooth connection. Compatible only with Maestro+ stoves, not compatible with hydro stoves	4024002 81.90

EIKO NATURAL MATIC 6 CORE UP NEW

Model: EIKO NATURALMATIC 6 UP! M1 CORE

POWER kW					
6	92	8	126-129	0,7-1,4	15

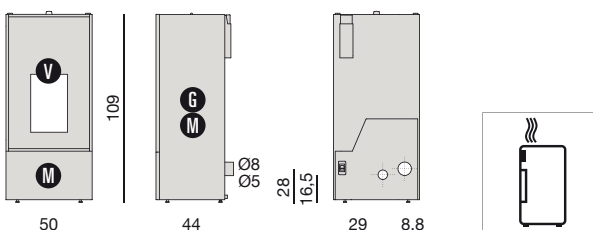



303



305

MAKO C.AIR MATIC 8 CORE R

Model: MAKO COMFORT AIRMATIC 8R M1 CORE

POWER kW	%	cm	kg	kg/h	kg
8	92,9	8	161	0,6-1,9	29

core	maestro+	easy connect	air	comfort air	comfort air	comfort air	no air	hydro
natural	oyster	free	matic	quick start	brush less			
kit wi-fi								

	5 STELLE D.M. 186				
--	-----------------------------	--	--	--	--

	CODE	£
	MAKO C.AIR MATIC 8 CORE R DARK 303	7124030 3921.46
	MAKO C.AIR MATIC 8 CORE R BRONZE 305	7124031 3921.46

	Maestro smartphone app (free download)	
	Control panel "Lift" that integrates the ordinary functionalities with those of the emergency panel	
	Temperature probe	

	Maestro+ FREESTANDING thermostatic remote control Remote control with ambient thermostat and humidity sensor for room temperature control, always visible thanks to the e-ink display	4022002 269.85
	LIGHT Maestro+ thermostatic remote control unit Small dimensions and stove control with only two buttons. 3 preset modes: manual, automatic, comfort. Bluetooth connection. Compatible only with Maestro+ stoves, not compatible with hydro stoves	4024002 81.90
	Pellet level sensor	4018005 115.50

>>> Comfort Air® accessories
To build a Comfort Air® channelling system
> PELLETS_Accessories

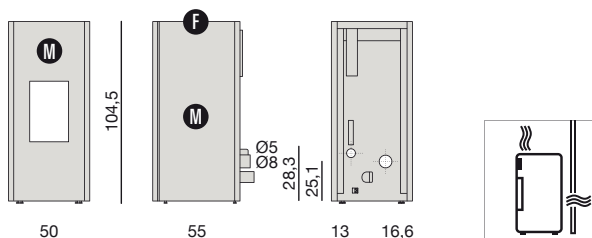

MAKO



TECLA



TECLA AIR 6 R TOP CHOICE

Model: TECLA AIR 6 M1

POWER kW	%	cm	kg	kg/h	kg
6,3	92	8	90	0,6-1,5	16

core	maestro	easy connect	air	comfort air	comfort air	comfort air	no air	hydro
natural	oyster	free	matic	quick start	brush less	no air	hydro	hydro
Wi-Fi	Wi-Fi	Wi-Fi	Wi-Fi	Wi-Fi	Wi-Fi	Wi-Fi	Wi-Fi	Wi-Fi

A	4 STELLE D.M. 186	CONTO TERMICO	Flame 7+		
---	-----------------------------	---------------	----------	--	--

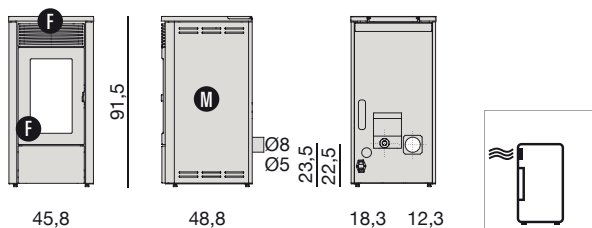

	CODE	£
TECLA AIR 6 R	7122001	1932.09

	302 White metal	6919006	109.03
	308 Dark metal	6919005	109.03
	313 Silver metal	6919008	109.03
	304 Bordeaux metal	6919007	109.03

	Maestro smartphone app (free download)		
--	--	--	--

	Control panel "Lift" that integrates the ordinary functionalities with those of the emergency panel		
--	---	--	--

	Temperature probe		
--	-------------------	--	--

	Maestro+ FREESTANDING thermostatic remote control Remote control with ambient thermostat and humidity sensor for room temperature control, always visible thanks to the e-ink display	4022002	269.95
--	--	---------	--------

	LIGHT Maestro+ thermostatic remote control unit Small dimensions and stove control with only two buttons. 3 preset modes: manual, automatic, comfort. Bluetooth connection. Compatible only with Maestro+ stoves, not compatible with hydro stoves	4024002	81.90
--	---	---------	-------

	Pellet level sensor	4018005	115.50
--	---------------------	---------	--------

	Black "ECO" ash pan	4017019	48.30
--	---------------------	---------	-------



EGO





	CODE	£
EGO AIR MATIC 8 CORE R	7124029	2674.98
EGO C.AIR MATIC 10 CORE R	7124032	2952.18

	302 White metal	6921001	269.81
	308 Dark metal	6921002	269.81
	313 Silver metal	6921003	269.81
	304 Bordeaux metal	6921004	269.81

maestro Maestro smartphone app (free download)

Control panel "Lift" that integrates the ordinary functionalities with those of the emergency panel

Temperature probe

Maestro+ FREESTANDING thermostatic remote control 4022002 269.85
Remote control with ambient thermostat and humidity sensor for room temperature control, always visible thanks to the e-ink display

LIGHT Maestro+ thermostatic remote control unit 4024002 81.90
Small dimensions and stove control with only two buttons. 3 preset modes: manual, automatic, comfort. Bluetooth connection. Compatible only with Maestro+ stoves, not compatible with hydro stoves

Pellet level sensor 4018005 115.50

Comfort Air® accessories
To build a Comfort Air® channelling system
> PELLET_Accessories

EGO AIR MATIC 8 CORE R TOP CHOICE

Model: EGO AIRMATIC 8R M3 CORE

POWER kW	%	cm	kg	kg/h	kg
8	92,9	8	130	0,6-1,9	25

core	maestro	easy connect	air	comfort air	comfort air	comfort air	no air	hydro
natural	oyster	free	matic	quick start	brush less	stove	pellet	hydro
Wi-Fi	Wi-Fi	Wi-Fi	Wi-Fi	Wi-Fi	Wi-Fi	Wi-Fi	Wi-Fi	Wi-Fi



EGO C.AIR MATIC 10 CORE R TOP CHOICE

Model: EGO COMFORT AIRMATIC 10R M3 CORE

POWER kW	%	cm	kg	kg/h	kg
10	92,9	8	133	0,6-2,3	25

core	maestro	easy connect	air	comfort air	comfort air	comfort air	no air	hydro
natural	oyster	free	matic	quick start	brush less	stove	pellet	hydro
Wi-Fi	Wi-Fi	Wi-Fi	Wi-Fi	Wi-Fi	Wi-Fi	Wi-Fi	Wi-Fi	Wi-Fi

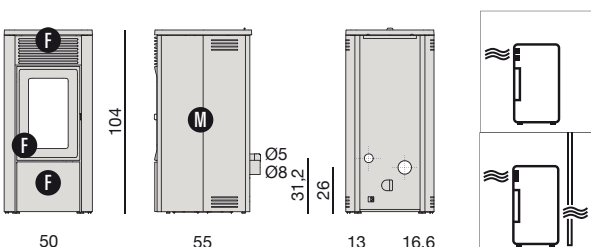

EGO



302



308



313



304

EGO AIR 8 R TOP CHOICE

Model: EGO AIR 8 M3

POWER kW	%	cm	kg	kg/h	kg
8,1	91,5	8	127	0,8-1,8	25

core	maestro+	easy connect	air	comfort air	comfort air	comfort air	no air	hydro
natural	oyster	free	matic	quick start	brush less			
kit wi-fi								

	4 STELLE D.M. 186			
--	-----------------------------	--	--	--

	CODE	£
EGO AIR 8 R	7122038	2259.18

	302 White metal	6921001	269.81
	308 Dark metal	6921002	269.81
	313 Silver metal	6921003	269.81
	304 Bordeaux metal	6921004	269.81

Maestro smartphone app (free download)

Control panel "Lift" that integrates the ordinary functionalities with those of the emergency panel

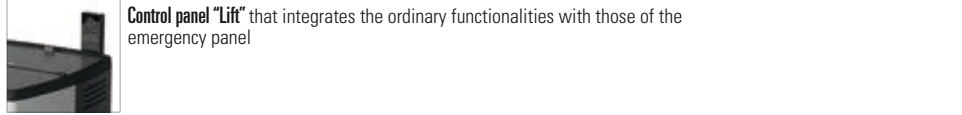

Temperature probe

Maestro+ FREESTANDING thermostatic remote control

Remote control with ambient thermostat and humidity sensor for room temperature control, always visible thanks to the e-ink display

LIGHT Maestro+ thermostatic remote control unit
Small dimensions and stove control with only two buttons. 3 preset modes: manual, automatic, comfort. Bluetooth connection. Compatible only with Maestro+ stoves, not compatible with hydro stoves

Pellet level sensor

Comfort Air® accessories
To build a Comfort Air® channelling system
> PELLET_Accessories

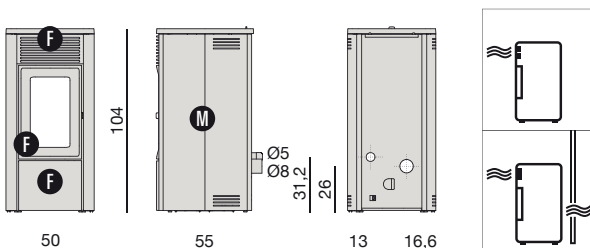

EGO AIR 8 UP

TOP CHOICE

Model: EGO AIR 8 UP! M3

POWER kW	%	cm	kg	kg/h	kg
8,1	91,5	8	130	0,8-1,8	21

core	maestro	easy connect	air	comfort air	comfort air	comfort air	no air	hydro
natural	oyster	free	matic	quick start	brush less	stove	stove	stove
Wi-Fi	Wi-Fi	Wi-Fi	Wi-Fi	Wi-Fi	Wi-Fi	Wi-Fi	Wi-Fi	Wi-Fi

	4 STELLE D.M. 186				
--	-----------------------------	--	--	--	--

EGO AIR 8 XUP

TOP CHOICE

Model: EGO AIR 8 XUP! M3

POWER kW	%	cm	kg	kg/h	kg
8,1	91,5	8/13	130	0,8-1,8	21

core	maestro	easy connect	air	comfort air	comfort air	comfort air	no air	hydro
natural	oyster	free	matic	quick start	brush less	stove	stove	stove
Wi-Fi	Wi-Fi	Wi-Fi	Wi-Fi	Wi-Fi	Wi-Fi	Wi-Fi	Wi-Fi	Wi-Fi

	4 STELLE D.M. 186				
--	-----------------------------	--	--	--	--

	CODE	£
EGO AIR 8 UP	7122039	2406.12
EGO AIR 8 XUP	7122040	2552.09

	302 White metal	6921001	269.81
	308 Dark metal	6921002	269.81
	313 Silver metal	6921003	269.81
	304 Bordeaux metal	6921004	269.81

	Maestro smartphone app (free download)		
--	---	--	--

	Control panel "Lift" that integrates the ordinary functionalities with those of the emergency panel		
--	--	--	--

	Temperature probe		
--	--------------------------	--	--

	Maestro+ FREESTANDING thermostatic remote control Remote control with ambient thermostat and humidity sensor for room temperature control, always visible thanks to the e-ink display	4022002	269.85
--	---	---------	--------

	LIGHT Maestro+ thermostatic remote control unit Small dimensions and stove control with only two buttons. 3 preset modes: manual, automatic, comfort. Bluetooth connection. Compatible only with Maestro+ stoves, not compatible with hydro stoves	4024002	81.90
--	--	---------	-------

	Pellet level sensor	4018005	115.50
--	----------------------------	---------	--------

	Adapter for coaxial flues only for XUP stoves mm 80/130 » 80/125	4019014	60.90
--	--	---------	-------

	Comfort Air® accessories To build a Comfort Air® channelling system > PELLET_Accessories		
--	---	--	--

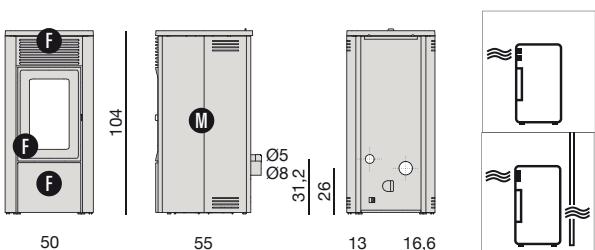

STAR





STAR



102



126



113



105

STAR AIR 8 R

TOP CHOICE

Model: STAR AIR 8 M3

POWER kW	%	cm	kg	kg/h	kg
8,1	91,5	8	127	0,8-1,8	25

core	maestro	easy connect	air	comfort air	comfort air	comfort air	no air	hydro
natural	oyster	free	matic	quick start	brush less	brush less	brush less	brush less
((o))	kit wi-fi	hand	hand	hand	hand	hand	hand	hand

A	4 STELLE D.M. 186	CONTO TERMICO	Flame 7*	Flame 7*	Flame 7*
---	-----------------------------	---------------	----------	----------	----------

STAR C.AIR 10 R

TOP CHOICE

Model: STAR COMFORT AIR 10 M3

POWER kW	%	cm	kg	kg/h	kg
10	91,5	8	130	0,8-2,3	25

core	maestro	easy connect	air	comfort air	comfort air	comfort air	no air	hydro
natural	oyster	free	matic	quick start	brush less	brush less	brush less	brush less
((o))	kit wi-fi	hand	hand	hand	hand	hand	hand	hand

A	4 STELLE D.M. 186	CONTO TERMICO	Flame 7*	Flame 7*	Flame 7*
---	-----------------------------	---------------	----------	----------	----------

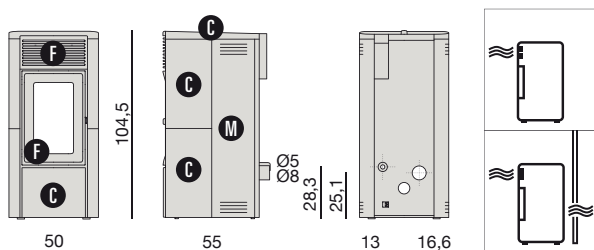

	CODE	£
STAR AIR 8 R	7122043	2225.92
STAR C.AIR 10 R	7122045	2410.72

	102 White ceramic	6921005	563.64
	126 Matt black ceramic	6921007	563.64
	113 Warm grey ceramic	6921008	563.64
	105 Bordeaux ceramic	6921006	563.64

Maestro smartphone app (free download)

Control panel "Lift" that integrates the ordinary functionalities with those of the emergency panel

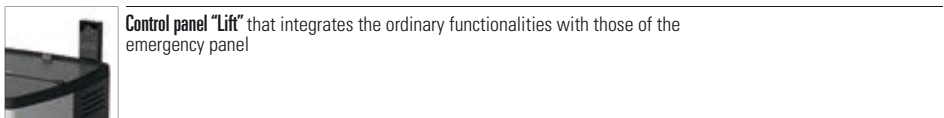

Temperature probe



Maestro+ FREESTANDING thermostatic remote control 4022002 269.85
Remote control with ambient thermostat and humidity sensor for room temperature control, always visible thanks to the e-ink display

LIGHT Maestro+ thermostatic remote control unit 4024002 81.90
Small dimensions and stove control with only two buttons. 3 preset modes: manual, automatic, comfort. Bluetooth connection. Compatible only with Maestro+ stoves, not compatible with hydro stoves

Pellet level sensor 4018005 115.50

Comfort Air® accessories
To build a Comfort Air® channelling system
> PELLET_Accessories

STAR



STAR AIR 8 UP TOP CHOICE

Model: STAR AIR 8 UPI M3

POWER kW	%	cm	kg	kg/h	kg
8,1	91,5	8	130	0,8-1,8	21

core	maestro+	easy connect	air	comfort air	comfort air	comfort air	no air	hydro
natural	oyster	free	matic	quick start	brush less	no air	hydro	hydro
kit wi-fi	kit wi-fi	kit wi-fi	kit wi-fi	kit wi-fi	kit wi-fi	kit wi-fi	kit wi-fi	kit wi-fi



STAR C.AIR 10 UP

Model: STAR COMFORT AIR 10 UPI M3

POWER kW	%	cm	kg	kg/h	kg
10	91,5	8	133	0,8-2,3	21

core	maestro+	easy connect	air	comfort air	comfort air	comfort air	no air	hydro
natural	oyster	free	matic	quick start	brush less	no air	hydro	hydro
kit wi-fi	kit wi-fi	kit wi-fi	kit wi-fi	kit wi-fi	kit wi-fi	kit wi-fi	kit wi-fi	kit wi-fi

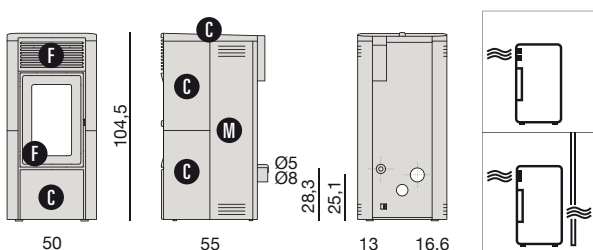

	CODE	£
STAR AIR 8 UP	7122044	2353.43
STAR C.AIR 10 UP	7122046	2609.38

	102 White ceramic	6921005	563.64
	126 Matt black ceramic	6921007	563.64
	113 Warm grey ceramic	6921008	563.64
	105 Bordeaux ceramic	6921006	563.64

Maestro smartphone app (free download)

	Control panel "Lift" that integrates the ordinary functionalities with those of the emergency panel		
--	---	--	--

	Temperature probe		
--	-------------------	--	--

Maestro+ FREESTANDING thermostatic remote control

	Remote control with ambient thermostat and humidity sensor for room temperature control, always visible thanks to the e-ink display	4022002	269.85
--	---	---------	--------

	LIGHT Maestro+ thermostatic remote control unit Small dimensions and stove control with only two buttons. 3 preset modes: manual, automatic, comfort. Bluetooth connection. Compatible only with Maestro+ stoves, not compatible with hydro stoves	4024002	81.90
--	---	---------	-------

	Pellet level sensor	4018005	115.50
--	---------------------	---------	--------

	Comfort Air® accessories To build a Comfort Air® channelling system > PELLET_Accessories		
--	--	--	--

MUSA



MUSA AIR MATIC 10 CORE R

Model: MUSA AIRMATIC 10R M3 CORE

POWER kW	%	cm	kg	kg/h	kg
10	92,9	8	165	0,6-2,3	30

core	maestro	easy connect	air	comfort air	comfort air	comfort air	no air	hydro
natural	oyster	free	matic	quick start	brush less	stove	stove	stove
Wi-Fi	Wi-Fi	Wi-Fi	Wi-Fi	Wi-Fi	Wi-Fi	Wi-Fi	Wi-Fi	Wi-Fi

	5 STELLE D.M. 186		7*		
--	-----------------------------	--	----	--	--

MUSA C.AIR MATIC 12 CORE R

Model: MUSA COMFORT AIRMATIC 12R M3 CORE

POWER kW	%	cm	kg	kg/h	kg
12	93,8	8	183	1,1-2,7	26

core	maestro	easy connect	air	comfort air	comfort air	comfort air	no air	hydro
natural	oyster	free	matic	quick start	brush less	stove	stove	stove
Wi-Fi	Wi-Fi	Wi-Fi	Wi-Fi	Wi-Fi	Wi-Fi	Wi-Fi	Wi-Fi	Wi-Fi

	5 STELLE D.M. 186		7*		
--	-----------------------------	--	----	--	--

MUSA C.AIR MATIC 14 CORE R

Model: MUSA COMFORT AIRMATIC 14R M3 CORE

POWER kW	%	cm	kg	kg/h	kg
14,1	93,8	8	183	1,1-3,2	26

core	maestro	easy connect	air	comfort air	comfort air	comfort air	no air	hydro
natural	oyster	free	matic	quick start	brush less	stove	stove	stove
Wi-Fi	Wi-Fi	Wi-Fi	Wi-Fi	Wi-Fi	Wi-Fi	Wi-Fi	Wi-Fi	Wi-Fi

	5 STELLE D.M. 186		7*		
--	-----------------------------	--	----	--	--

	CODE	£
MUSA AIR MATIC 10 CORE R	7124034	2776.62
MUSA C.AIR MATIC 12 CORE R	7124036	3160.08
MUSA C.AIR MATIC 14 CORE R	7124038	3349.50

	302 White metal	6921026	388.08
	308 Dark metal	6921027	388.08
	313 Silver metal	6921028	388.08
	304 Bordeaux metal	6921029	388.08

	Maestro smartphone app (free download)		
--	--	--	--

	Control panel "Lift" that integrates the ordinary functionalities with those of the emergency panel		
--	---	--	--

	Temperature probe		
--	-------------------	--	--

	Maestro+ FREESTANDING thermostatic remote control Remote control with ambient thermostat and humidity sensor for room temperature control, always visible thanks to the e-ink display	4022002	269.85
--	--	---------	--------

	LIGHT Maestro+ thermostatic remote control unit Small dimensions and stove control with only two buttons. 3 preset modes: manual, automatic, comfort. Bluetooth connection. Compatible only with Maestro+ stoves, not compatible with hydro stoves	4024002	81.90
--	---	---------	-------

	Pellet level sensor	4018005	115.50
--	---------------------	---------	--------

	Comfort Air® accessories To build a Comfort Air® channelling system > PELLET_Accessories		
--	--	--	--

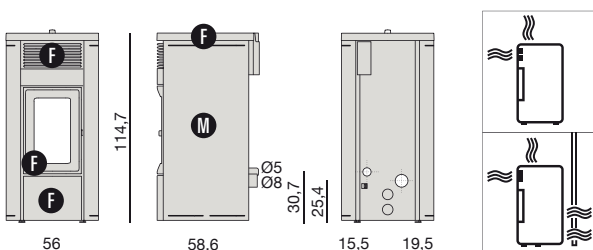

MUSA

MUSA AIR 10 R

TOP CHOICE

Model: MUSA AIR 10 M3

POWER kW	%	cm	kg	kg/h	kg
10	91,5	8	165	0,8-2,3	30

core	maestro	easy connect	air	comfort air	comfort air	comfort air	no air	hydro
natural	oyster	free	matic	quick start	brush less	stove	stove	stove
Wi-Fi	Wi-Fi	Wi-Fi	Wi-Fi	Wi-Fi	Wi-Fi	Wi-Fi	Wi-Fi	Wi-Fi

A G	4 STELLE D.M. 186	CONTO TERMICO	Flame 7+		
-----	-----------------------------	---------------	----------	--	--

	CODE	£
MUSA AIR 10 R	7122053	2367.96

	302 White metal	6921026	363.83
	308 Dark metal	6921027	363.83
	313 Silver metal	6921028	363.83
	304 Bordeaux metal	6921029	363.83

	Maestro smartphone app (free download)		
--	--	--	--

	Control panel "Lif" that integrates the ordinary functionalities with those of the emergency panel		
--	--	--	--

	Temperature probe		
--	-------------------	--	--

Maestro+ FREESTANDING thermostatic remote control

	Remote control with ambient thermostat and humidity sensor for room temperature control, always visible thanks to the e-ink display	4022002	269.85
--	---	---------	--------

	LIGHT Maestro+ thermostatic remote control unit Small dimensions and stove control with only two buttons. 3 preset modes: manual, automatic, comfort. Bluetooth connection. Compatible only with Maestro+ stoves, not compatible with hydro stoves	4024002	81.90
--	---	---------	-------

	Pellet level sensor	4018005	115.50
--	---------------------	---------	--------

	Comfort Air® accessories To build a Comfort Air® channelling system > PELLET_Accessories		
--	--	--	--

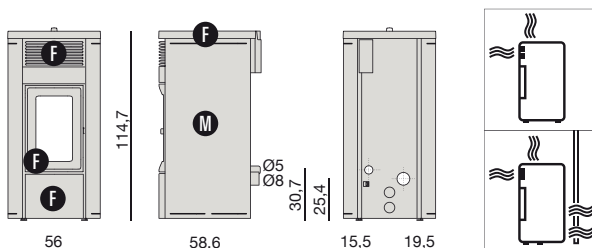

MUSA

MUSA AIR 10 UP

TOP CHOICE

Model: MUSA AIR 10 UP! M3

POWER kW	%	cm	kg	kg/h	kg
10	91,5	8	165	0,8-2,3	30

core	maestro	easy connect	air	comfort air	comfort air	comfort air	no air	hydro
natural	oyster	free	matic	quick start	calendar	brush less	stove	mobile
Wi-Fi	touch	control panel	channelling	stove	stove	stove	stove	stove

A	4 STELLE D.M. 186	CONTO TERMICO	Flama 7+	
---	-----------------------------	---------------	----------	--

	CODE	£
MUSA AIR 10 UP	7122054	2557.80

	302 White metal	6921026	363.83
	308 Dark metal	6921027	363.83
	313 Silver metal	6921028	363.83
	304 Bordeaux metal	6921029	363.83

	Maestro smartphone app (free download)		
--	---	--	--

	Control panel "Lift" that integrates the ordinary functionalities with those of the emergency panel		
--	--	--	--

	Temperature probe		
--	--------------------------	--	--

Accessories

	Maestro+ FREESTANDING thermostatic remote control Remote control with ambient thermostat and humidity sensor for room temperature control, always visible thanks to the e-ink display	4022002	269.85
--	---	---------	--------

	LIGHT Maestro+ thermostatic remote control unit Small dimensions and stove control with only two buttons. 3 preset modes: manual, automatic, comfort. Bluetooth connection. Compatible only with Maestro+ stoves, not compatible with hydro stoves	4024002	81.90
--	--	---------	-------

	Pellet level sensor	4018005	115.50
--	----------------------------	---------	--------

	Adapter for coaxial flues only for XUP stoves mm 80/130 » 80/125	4019014	60.90
--	--	---------	-------

	Comfort Air® accessories To build a Comfort Air® channelling system > PELLET_Accessories		
--	---	--	--

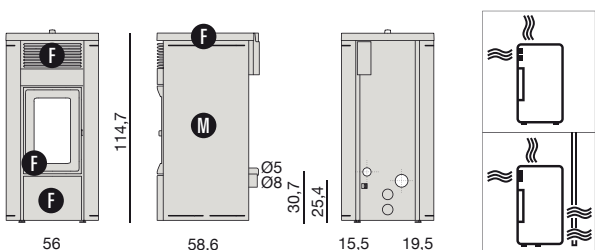

CLUB





CLUB AIR MATIC 10 CORE R

Model: CLUB AIR MATIC 10R M3 CORE

POWER kW	%	cm	kg	kg/h	kg
10	92,9	8	165	0,6-2,3	30

core	maestro	easy connect	air	comfort air	comfort air	comfort air	no air	hydro
natural	oyster	free	matic	quick start	brush less	brush less	brush less	brush less
Wi-Fi	Wi-Fi	Wi-Fi	Wi-Fi	Wi-Fi	Wi-Fi	Wi-Fi	Wi-Fi	Wi-Fi

A G	5 STELLE D.M. 186	CONTO TERMICO	Flame 7+	Flame 7+	Flame 7+
-----	-----------------------------	---------------	----------	----------	----------

CLUB C.AIR MATIC 12 CORE R

Model: CLUB COMFORT AIR MATIC 12R M3 CORE

POWER kW	%	cm	kg	kg/h	kg
12	93,8	8	183	1,1-2,7	26

core	maestro	easy connect	air	comfort air	comfort air	comfort air	no air	hydro
natural	oyster	free	matic	quick start	brush less	brush less	brush less	brush less
Wi-Fi	Wi-Fi	Wi-Fi	Wi-Fi	Wi-Fi	Wi-Fi	Wi-Fi	Wi-Fi	Wi-Fi

A G	5 STELLE D.M. 186	CONTO TERMICO	Flame 7+	Flame 7+	Flame 7+
-----	-----------------------------	---------------	----------	----------	----------

CLUB C.AIR MATIC 14 CORE R

Model: CLUB COMFORT AIR MATIC 14R M3 CORE

POWER kW	%	cm	kg	kg/h	kg
14,1	93,8	8	183	1,1-3,2	26

core	maestro	easy connect	air	comfort air	comfort air	comfort air	no air	hydro
natural	oyster	free	matic	quick start	brush less	brush less	brush less	brush less
Wi-Fi	Wi-Fi	Wi-Fi	Wi-Fi	Wi-Fi	Wi-Fi	Wi-Fi	Wi-Fi	Wi-Fi

A G	5 STELLE D.M. 186	CONTO TERMICO	Flame 7+	Flame 7+	Flame 7+
-----	-----------------------------	---------------	----------	----------	----------

CLUB CERAMIC

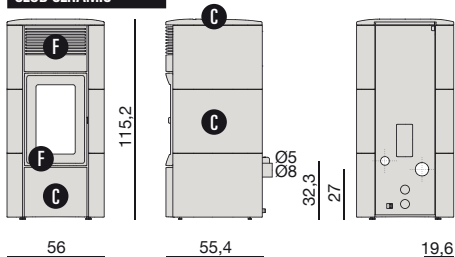

CLUB ABSOLUTE

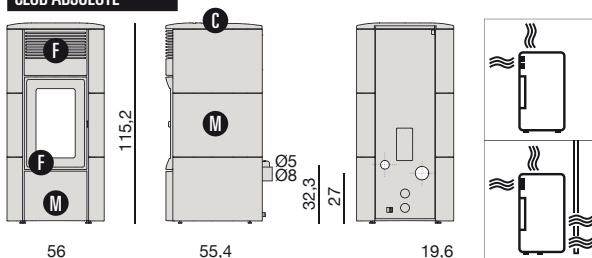

	CODE	€
CLUB AIR MATIC 10 CORE R	7124033	2912.28
CLUB C.AIR MATIC 12 CORE R	7124035	3333.79
CLUB C.AIR MATIC 14 CORE R	7124037	3580.50

			€
	102 White ceramic	6921018	634.79
	126 Matt Black ceramic	6921020	634.79
	109 Sand ceramic	6921021	634.79
	105 Bordeaux ceramic	6921019	634.79

	Maestro smartphone app (free download)		
--	--	--	--

	Control panel "Lift" that integrates the ordinary functionalities with those of the emergency panel		
--	---	--	--

	Temperature probe		
--	-------------------	--	--

	Maestro+ FREESTANDING thermostatic remote control Remote control with ambient thermostat and humidity sensor for room temperature control, always visible thanks to the e-ink display	4022002	269.85
--	--	---------	--------

	LIGHT Maestro+ thermostatic remote control unit Small dimensions and stove control with only two buttons. 3 preset modes: manual, automatic, comfort. Bluetooth connection. Compatible only with Maestro+ stoves, not compatible with hydro stoves	4024002	81.90
--	---	---------	-------

	Pellet level sensor	4018005	115.50
--	---------------------	---------	--------

	Comfort Air® accessories To build a Comfort Air® channelling system > PELLETT_Accessories		
--	---	--	--

CLUB

CLUB AIR 10 R

TOP CHOICE

Model: CLUB AIR 10 M3

POWER kW	%	cm	kg	kg/h	kg
10	91,5	8	165	0,8-2,3	30

core	maestro	easy connect	air	comfort air	comfort air	comfort air	no air	hydro
natural	oyster	free	matic	quick start	brush less			
Wi-Fi								

	4 STELLE D.M. 186			
--	-----------------------------	--	--	--

CLUB AIR 10 R	CODE	£
	7122049	2476.32

	102 White ceramic	6921018	595.12
	126 Matt Black ceramic	6921020	595.12
	109 Sand ceramic	6921021	595.12
	105 Bordeaux ceramic	6921019	595.12

	Maestro smartphone app (free download)		
	Control panel "Lift" that integrates the ordinary functionalities with those of the emergency panel		
	Temperature probe		
	Maestro+ FREESTANDING thermostatic remote control Remote control with ambient thermostat and humidity sensor for room temperature control, always visible thanks to the e-ink display	4022002	269.85
	LIGHT Maestro+ thermostatic remote control unit Small dimensions and stove control with only two buttons. 3 preset modes: manual, automatic, comfort. Bluetooth connection. Compatible only with Maestro+ stoves, not compatible with hydro stoves	4024002	81.90
	Pellet level sensor	4018005	115.50
	Comfort Air® accessories To build a Comfort Air® channelling system > PELLET_Accessories		

CLUB CERAMIC

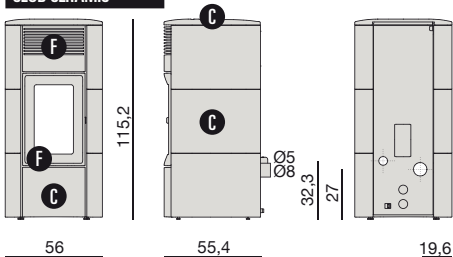

CLUB ABSOLUTE

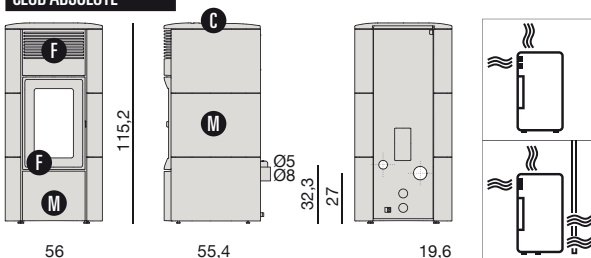

CLUB



CLUB AIR 10 UP

TOP CHOICE

Model: CLUB AIR 10 UP! M3

POWER kW	%	cm	kg	kg/h	kg
10	91,5	8	165	0,8-2,3	30

core	maestro+	easy connect	air	comfort air	comfort air	comfort air	no air	hydro
natural	oyster	free	matic	quick start	brush less	no air	hydro	hydro
kit wi-fi	kit wi-fi	kit wi-fi	kit wi-fi	kit wi-fi	kit wi-fi	kit wi-fi	kit wi-fi	kit wi-fi

A	4 STELLE D.M. 186	CONTO TERMICO	flame 7+	eco
---	-----------------------------	---------------	----------	-----

	CODE	£
CLUB AIR 10 UP	7122050	2713.79
CLUB C.AIR 12 UP	7122052	3567.90

102 White ceramic	6921018	595.12
126 Matt Black ceramic	6921020	595.12
109 Sand ceramic	6921021	595.12
105 Bordeaux ceramic	6921019	595.12

Accessories

maestro	Maestro smartphone app (free download)		
Control panel "Lift"	Control panel "Lift" that integrates the ordinary functionalities with those of the emergency panel		
Temperature probe	Temperature probe		
Maestro+ FREESTANDING thermostatic remote control	Remote control with ambient thermostat and humidity sensor for room temperature control, always visible thanks to the e-ink display	4022002	269.85
LIGHT Maestro+ thermostatic remote control unit	Small dimensions and stove control with only two buttons. 3 preset modes: manual, automatic, comfort. Bluetooth connection. Compatible only with Maestro+ stoves, not compatible with hydro stoves	4024002	81.90
Pellet level sensor		4018005	115.50
Adapter for coaxial flues only for XUP stoves	mm 80/130 » 80/125	4019014	60.90
Comfort Air® accessories	To build a Comfort Air® channelling system > PELLET_Accessories		

CLUB CERAMIC

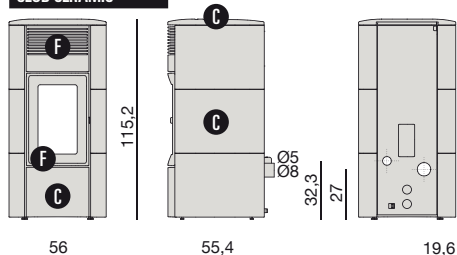

CLUB ABSOLUTE

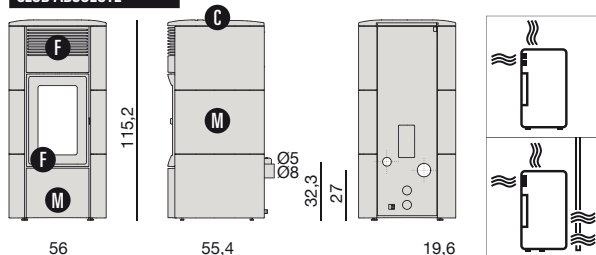

CLUB

CLUB



CLUB ABSOLUTE



SUITE



SUITE AIR MATIC 10 CORE R

Model: SUITE AIRMATIC 10R M3 CORE

POWER kW	%	cm	kg	kg/h	kg
10	92,9	8	165	0,6-2,3	30

core	maestro	easy connect	air	comfort air	comfort air	comfort air	no air	hydro
natural	oyster	free	matic	quick start	brush less	stove	stove	stove
Wi-Fi	Wi-Fi	Wi-Fi	Wi-Fi	Wi-Fi	Wi-Fi	Wi-Fi	Wi-Fi	Wi-Fi

A	5 STELLE D.M. 186	CONTO TERMICO	Flame 7*	eco	eco
---	-----------------------------	---------------	-----------------	-----	-----

SUITE C.AIR MATIC 12 CORE R

Model: SUITE COMFORT AIRMATIC 12R M3 CORE

POWER kW	%	cm	kg	kg/h	kg
12	93,8	8	183	1,1-2,7	26

core	maestro	easy connect	air	comfort air	comfort air	comfort air	no air	hydro
natural	oyster	free	matic	quick start	brush less	stove	stove	stove
Wi-Fi	Wi-Fi	Wi-Fi	Wi-Fi	Wi-Fi	Wi-Fi	Wi-Fi	Wi-Fi	Wi-Fi

A	5 STELLE D.M. 186	CONTO TERMICO	Flame 7*	eco	eco
---	-----------------------------	---------------	-----------------	-----	-----

SUITE C.AIR MATIC 14 CORE R

TOP CHOICE

Model: SUITE COMFORT AIRMATIC 14R M3 CORE

POWER kW	%	cm	kg	kg/h	kg
14,1	93,8	8	183	1,1-3,2	26

core	maestro	easy connect	air	comfort air	comfort air	comfort air	no air	hydro
natural	oyster	free	matic	quick start	brush less	stove	stove	stove
Wi-Fi	Wi-Fi	Wi-Fi	Wi-Fi	Wi-Fi	Wi-Fi	Wi-Fi	Wi-Fi	Wi-Fi

A	5 STELLE D.M. 186	CONTO TERMICO	Flame 7*	eco	eco
---	-----------------------------	---------------	-----------------	-----	-----

	CODE	£
SUITE AIR MATIC 10 CORE R	7124033	2912.28
SUITE C.AIR MATIC 12 CORE R	7124035	3333.79
SUITE C.AIR MATIC 14 CORE R	7124037	3580.50

	113 Warm Grey ceramic	6921017	595.12
	105 Bordeaux ceramic	6921015	595.12
	126 Matt Black ceramic	6921016	595.12
	110 Salt and pepper ceramic	6921014	595.12

	Maestro smartphone app (free download)		
--	--	--	--

	Control panel "Lift" that integrates the ordinary functionalities with those of the emergency panel		
--	---	--	--

	Temperature probe		
--	-------------------	--	--

	Maestro+ FREESTANDING thermostatic remote control Remote control with ambient thermostat and humidity sensor for room temperature control, always visible thanks to the e-ink display	4022002	269.85
--	--	---------	--------

	LIGHT Maestro+ thermostatic remote control unit Small dimensions and stove control with only two buttons. 3 preset modes: manual, automatic, comfort. Bluetooth connection. Compatible only with Maestro+ stoves, not compatible with hydro stoves	4024002	81.90
--	---	---------	-------

	Pellet level sensor	4018005	115.50
--	---------------------	---------	--------

	Comfort Air® accessories To build a Comfort Air® channelling system > PELLET_Accessories		
--	--	--	--

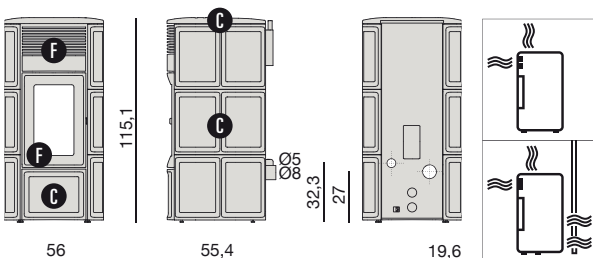

SUITE

SUITE AIR 10 R

TOP CHOICE

Model: SUITE AIR 10 M3

POWER kW					
10	91,5	8	165	0,8-2,3	30

core	maestro	easy connect	air	comfort air	comfort air	comfort air	no air	hydro
natural	oyster	free	matic	quick start	brush less	brush less	brush less	brush less
Wi-Fi	Wi-Fi	Wi-Fi	Wi-Fi	Wi-Fi	Wi-Fi	Wi-Fi	Wi-Fi	Wi-Fi

	4 STELLE D.M. 186				
A	4 STELLE D.M. 186	CONTO TERMICO	Flame 7+	Flame 7+	Flame 7+

	CODE	€
SUITE AIR 10 R	7122049	2476.32

	113 Warm Grey ceramic	6921017	595.12
	105 Bordeaux ceramic	6921015	595.12
	126 Matt Black ceramic	6921016	595.12
	110 Salt and pepper ceramic	6921014	595.12

	Maestro smartphone app (free download)		
--	--	--	--

	Control panel "Lift" that integrates the ordinary functionalities with those of the emergency panel		
--	---	--	--

	Temperature probe		
--	-------------------	--	--

	Maestro+ FREESTANDING thermostatic remote control Remote control with ambient thermostat and humidity sensor for room temperature control, always visible thanks to the e-ink display	4022002	269.85
--	--	---------	--------

	LIGHT Maestro+ thermostatic remote control unit Small dimensions and stove control with only two buttons. 3 preset modes: manual, automatic, comfort. Bluetooth connection. Compatible only with Maestro+ stoves, not compatible with hydro stoves	4024002	81.90
--	---	---------	-------

	Pellet level sensor	4018005	115.50
--	---------------------	---------	--------

	Comfort Air® accessories To build a Comfort Air® channelling system > PELLET_Accessories		
--	--	--	--

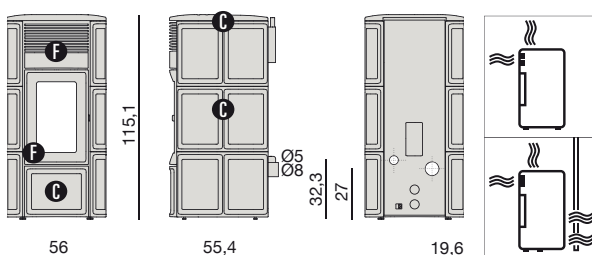

SUITE



SUITE AIR 10 UP

TOP CHOICE

Model: SUITE AIR 10 UP! M3

POWER kW	%	cm	kg	kg/h	kg
10	91,5	8	165	0,8-2,3	30

core	maestro+	easy connect	air	comfort air	comfort air	comfort air	no air	hydro
natural	oyster	free	matic	quick start	brush less			

	4 STELLE D.M. 186			
--	-----------------------------	--	--	--

	CODE	£
SUITE AIR 10 UP	7122050	2713.79
113 Warm Grey ceramic	6921017	595.12
105 Bordeaux ceramic	6921015	595.12
126 Matt Black ceramic	6921016	595.12
110 Salt and pepper ceramic	6921014	595.12

	Maestro smartphone app (free download)	
--	--	--

	Control panel "Lift" that integrates the ordinary functionalities with those of the emergency panel	
--	---	--

	Temperature probe	
--	-------------------	--

	Maestro+ FREESTANDING thermostatic remote control Remote control with ambient thermostat and humidity sensor for room temperature control, always visible thanks to the e-ink display	4022002	269.85
--	--	---------	--------

	LIGHT Maestro+ thermostatic remote control unit Small dimensions and stove control with only two buttons. 3 preset modes: manual, automatic, comfort. Bluetooth connection. Compatible only with Maestro+ stoves, not compatible with hydro stoves	4024002	81.90
--	---	---------	-------

	Pellet level sensor	4018005	115.50
--	---------------------	---------	--------

	Adapter for coaxial flues only for XUP stoves mm 80/130 » 80/125	4019014	60.90
--	---	---------	-------

	Comfort Air® accessories To build a Comfort Air® channelling system > PELLET_Accessories		
--	--	--	--

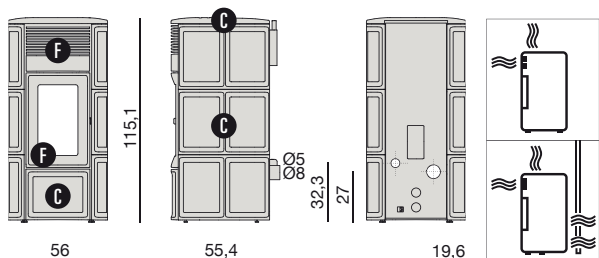



DECÒ AIR 8 UP TOP CHOICE

Model: DECÒ AIR 8 M1

POWER kW	%	cm	kg	kg/h	kg
8	94,3	8/10	200	0,5-1,8	15

core	maestro	easy connect	air	comfort air	comfort air	comfort air	no air	hydro
natural	oyster	free	matic	quick start	brush less	stove	stove	stove
Wi-Fi	Wi-Fi	maestro app	control panel	temperature probe	pellet level sensor	remote control	remote control	remote control

A	4 STELLE D.M. 186	CONTO TERMICO	Flame 7+		
---	-----------------------------	---------------	----------	--	--

	CODE	£
DECÒ AIR 8 UP	7122005	3580.50
maestro	Maestro smartphone app (free download)	
	Control panel "Lift" that integrates the ordinary functionalities with those of the emergency panel	
	Temperature probe	
	Maestro+ FREESTANDING thermostatic remote control Remote control with ambient thermostat and humidity sensor for room temperature control, always visible thanks to the e-ink display	4022002 269.85
	LIGHT Maestro+ thermostatic remote control unit Small dimensions and stove control with only two buttons. 3 preset modes: manual, automatic, comfort. Bluetooth connection. Compatible only with Maestro+ stoves, not compatible with hydro stoves	4024002 81.90
	Pellet level sensor	4018005 105.00

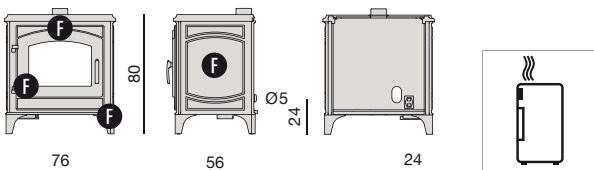

CUTE



CUTE AIR 8 UP

Model: CUTE AIR 8 M1

POWER kW	%	cm	kg	kg/h	kg
8	94,3	8/10	145	0,5-1,8	15

core	maestro	easy connect	air	comfort air	comfort air	comfort air	no air	hydro
natural	oyster	free	matic	quick start	brush less	no air	hydro	hydro
Wi-Fi	Wi-Fi	Wi-Fi	Wi-Fi	Wi-Fi	Wi-Fi	Wi-Fi	Wi-Fi	Wi-Fi

A	4 STELLE D.M. 186	CONTO TERMICO	flame 7*		
---	-----------------------------	---------------	----------	--	--

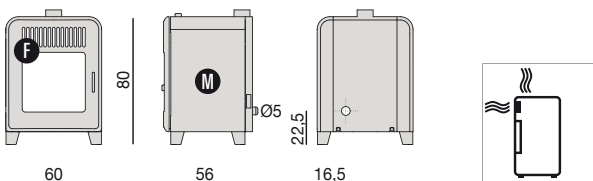

	CODE	£
CUTE AIR 8 UP	7122002	3012.24

	Maestro smartphone app (free download)		
	Control panel "Lift" that integrates the ordinary functionalities with those of the emergency panel		
	Temperature probe		
	Maestro+ FREESTANDING thermostatic remote control Remote control with ambient thermostat and humidity sensor for room temperature control, always visible thanks to the e-ink display	4022002	269.85
	LIGHT Maestro+ thermostatic remote control unit Small dimensions and stove control with only two buttons. 3 preset modes: manual, automatic, comfort. Bluetooth connection. Compatible only with Maestro+ stoves, not compatible with hydro stoves	4024002	81.90
	Pellet level sensor	4018005	115.50
	Part of the top - Cute/Thema In the case of installation with a rear smoke outlet	4019010	55.65



FEEL C.AIR MATIC 12 CORE R NEW

Model: FEEL COMFORT AIRMATIC 12 M1 CORE

POWER kW	%	cm	kg	kg/h	kg
12	93,8	8	180	1,1-2,7	31

core	maestro+	easy connect	air	comfort air	comfort air	comfort air	no air	hydro
natural	oyster	free	matic	quick start	brush less			
	kit wi-fi							

FEEL C.AIR MATIC 12 CORE UP NEW

Model: FEEL COMFORT AIRMATIC 12 UP! M1 CORE

POWER kW	%	cm	kg	kg/h	kg
12	93,8	8	180	1,1-2,7	31

core	maestro+	easy connect	air	comfort air	comfort air	comfort air	no air	hydro
natural	oyster	free	matic	quick start	brush less			
	kit wi-fi							

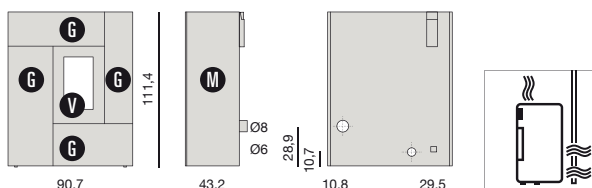

	CODE	£
FEEL C.AIR MATIC 12 CORE R	7124003	3646.10
FEEL C.AIR MATIC 12 CORE UP	7124007	3759.76

		CODE	£
	Custom (Grès with a maximum thickness of 3.5 mm)	6923011	231.00
	251 Materia Corten	6923012	303.07
	252 Materia Tortora	6923013	303.07
	253 Materia Piombo	6923014	303.07

maestro+ Maestro smartphone app (free download)

Control panel "Lift" that integrates the ordinary functionalities with those of the emergency panel

Temperature probe

Pellet level sensor

Maestro+ FREESTANDING thermostatic remote control 4022002 269.85
Remote control with ambient thermostat and humidity sensor for room temperature control, always visible thanks to the e-ink display

LIGHT Maestro+ thermostatic remote control unit 4024002 81.90
Small dimensions and stove control with only two buttons. 3 preset modes: manual, automatic, comfort. Bluetooth connection. Compatible only with Maestro+ stoves, not compatible with hydro stoves

Comfort Air® accessories
To build a Comfort Air® channelling system
> PELLETS_Accessories

FEEL



RAY

RAY C.AIR 8 R

Model: RAY COMFORT AIR 8 M2

POWER kW	%	cm	kg	kg/h	kg
7,8	90,2	8	155	0,8-1,8	18

core	maestro	easy connect	air	comfort air	comfort air	comfort air	no air	hydro
natural	oyster	free	matic	quick start	brush less	brush less	brush less	brush less
Wi-Fi	Wi-Fi	Wi-Fi	Wi-Fi	Wi-Fi	Wi-Fi	Wi-Fi	Wi-Fi	Wi-Fi

4 STELLE D.M. 186	CONTO TERMICO	Flamme VERDE 7*	
-----------------------------	----------------------	------------------------	--

RAY C.AIR 8 UP

Model: RAY COMFORT AIR 8 UP! M2

TOP CHOICE

POWER kW	%	cm	kg	kg/h	kg
7,8	90,2	8	155	0,8-1,8	18

core	maestro	easy connect	air	comfort air	comfort air	comfort air	no air	hydro
natural	oyster	free	matic	quick start	brush less	brush less	brush less	brush less
Wi-Fi	Wi-Fi	Wi-Fi	Wi-Fi	Wi-Fi	Wi-Fi	Wi-Fi	Wi-Fi	Wi-Fi

4 STELLE D.M. 186	CONTO TERMICO	Flamme VERDE 7*	
-----------------------------	----------------------	------------------------	--

RAY C.AIR 8 XUP

Model: RAY COMFORT AIR 8 XUP! M2

POWER kW	%	cm	kg	kg/h	kg
7,8	90,2	8/13	155	0,8-1,8	18

core	maestro	easy connect	air	comfort air	comfort air	comfort air	no air	hydro
natural	oyster	free	matic	quick start	brush less	brush less	brush less	brush less
Wi-Fi	Wi-Fi	Wi-Fi	Wi-Fi	Wi-Fi	Wi-Fi	Wi-Fi	Wi-Fi	Wi-Fi

4 STELLE D.M. 186	CONTO TERMICO	Flamme VERDE 7*	
-----------------------------	----------------------	------------------------	--

RAY METAL

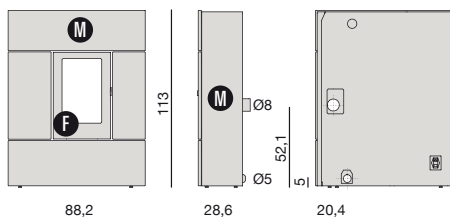

RAY CERAMIC

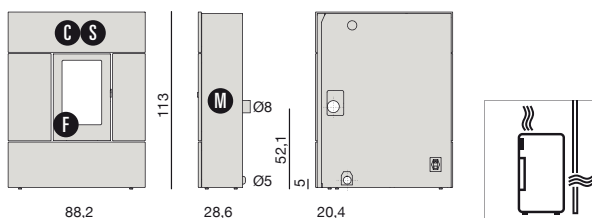

	CODE	€
RAY C.AIR 8 R	7122064	2794.18
RAY C.AIR 8 UP	7124009	2879.18
RAY C.AIR 8 XUP	7122066	3012.24

240 Serpentino	6918012	483.26
308 Dark metal	6920031	336.34
302 White metal	6920032	336.34

Maestro smartphone app (free download)		
---	--	--

Control panel "Lift" that integrates the ordinary functionalities with those of the emergency panel		
--	--	--

Temperature probe		
--------------------------	--	--

Maestro+ FREESTANDING thermostatic remote control Remote control with ambient thermostat and humidity sensor for room temperature control, always visible thanks to the e-ink display	4022002	269.85
---	---------	--------

LIGHT Maestro+ thermostatic remote control unit Small dimensions and stove control with only two buttons. 3 preset modes: manual, automatic, comfort. Bluetooth connection. Compatible only with Maestro+ stoves, not compatible with hydro stoves	4024002	81.90
--	---------	-------

Pellet level sensor	4018005	115.50
----------------------------	---------	--------

Adapter for coaxial flues only for XUP stoves mm 80/130 » 80/125	4019014	60.90
--	---------	-------

Comfort Air® accessories To build a Comfort Air® channelling system > PELLET_Accessories		
---	--	--

RAY





	CODE	£
CURVE AIR MATIC 8 CORE UP	7124001	3646.10

	126 Matt Black ceramic	6923015	942.48
	113 Warm grey ceramic	6923016	942.48
	102 White ceramic	6923018	942.48
	127 Taupe ceramic	6924001	942.48

Maestro smartphone app (free download)

	Maestro+ FREESTANDING thermostatic remote control Remote control with ambient thermostat and humidity sensor for room temperature control, always visible thanks to the e-ink display
--	--

	Temperature probe
--	-------------------

Pellet level sensor

	Pellet level sensor	4018005	115.50
--	---------------------	---------	--------

CURVE AIR MATIC 8 CORE UP NEW

Model: CURVE AIRMATIC 8 UPI M2 CORE

POWER kW	%	cm	kg	kg/h	kg
8	92,9	8	130	0,6-1,9	18
core	maestro	easy connect	air	comfort air	comfort air
comfort air	comfort air	no air	hydro	natural	oyster
free	matic	quick start	brush less	kit wi-fi	hand
A F G	5 STELLE D.M. 186	CONTO TERMICO	flame 7+		

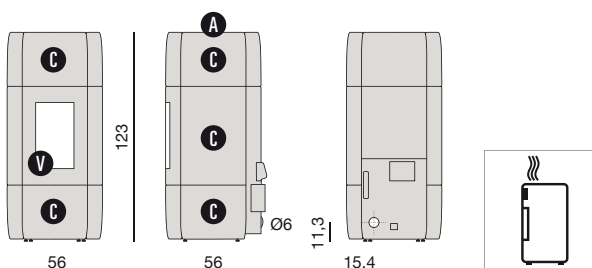

CURVE



MOOD





303



305

	CODE	£
MOOD C. AIR MATIC 8 CORE R	7124002	3683.99
303 Black metal		
	6923019	474.02
305 Bronze metal		
	6923020	474.02
Maestro smartphone app (free download)		
Maestro+ FREESTANDING thermostatic remote control Remote control with ambient thermostat and humidity sensor for room temperature control, always visible thanks to the e-ink display		
Temperature probe		
Pellet level sensor		
	4018005	115.50

MOOD C. AIR MATIC 8 CORE R NEW

Model: MOOD COMFORT AIRMATIC 8 M2 CORE

POWER kW	%	cm	kg	kg/h	kg
8	92,9	8	145	0,6-1,9	21
core	maestro	easy connect	air	comfort air	comfort air
natural	oyster	free	matic	quick start	brush less
no air	hydro	kit wi-fi	matic	quick start	brush less
A	5 STELLE D.M. 186	CONTO TERMICO	flame 7*	eco	eco

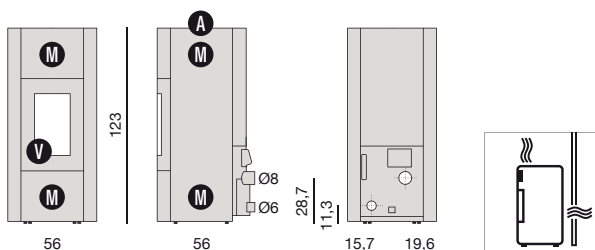

HALO



303



313



315



304

HALO AIR 8 R

TOP CHOICE

Model: HALO AIR 8 M2

POWER kW	%	cm	kg	kg/h	kg
8,1	91,5	8	130	0,8-1,8	21

core	maestro	easy connect	air	comfort air	comfort air	comfort air	no air	hydro
natural	oyster	free	matic	quick start	brush less	stove	pellet	hydro
Wi-Fi	kit	Wi-Fi	stove	stove	stove	stove	stove	stove

	4 STELLE D.M. 186			
--	-----------------------------	--	--	--

	CODE	£
HALO AIR 8 R	7122076	2812.66

	303 Black metal	6916015	222.69
	313 Silver metal	6916016	222.69
	315 Aluminium metal	6916017	222.69

	Maestro smartphone app (free download)	
	Control panel "Lift" that integrates the ordinary functionalities with those of the emergency panel	
	Temperature probe	

	Maestro+ FREESTANDING thermostatic remote control Remote control with ambient thermostat and humidity sensor for room temperature control, always visible thanks to the e-ink display	4022002	269.95
	LIGHT Maestro+ thermostatic remote control unit Small dimensions and stove control with only two buttons. 3 preset modes: manual, automatic, comfort. Bluetooth connection. Compatible only with Maestro+ stoves, not compatible with hydro stoves	4024002	81.90
	Pellet level sensor	4018005	115.50

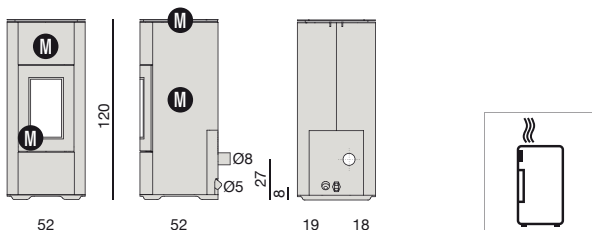

HALO



	CODE	£
HALO AIR 8 UP	7122022	4102.35
HALO AIR 8 XUP	7124040	3433.58

	303 Black metal	6916015	222.69
	313 Silver metal	6916016	222.69
	315 Aluminium metal	6916017	222.69

Maestro smartphone app (free download)

Maestro+ FREESTANDING thermostatic remote control
Remote control with ambient thermostat and humidity sensor for room temperature control, always visible thanks to the e-ink display

Temperature probe

Pellet level sensor 4018005 115.50

HALO HALO AIR 8 XUP NEW

Model: HALO AIR 8 XUP! M2

POWER kW	%	cm	kg	kg/h	kg
8,1	91,5	8/13	130	0,8-1,8	18

core	maestro	easy connect	air	comfort air	comfort air	comfort air	no air	hydro
natural	oyster	free	matic	quick start	brush less	stove	stove	stove
kit wi-fi	kit wi-fi	kit wi-fi	kit wi-fi	kit wi-fi	kit wi-fi	kit wi-fi	kit wi-fi	kit wi-fi

	4 STELLE D.M. 186				
--	-----------------------------	--	--	--	--

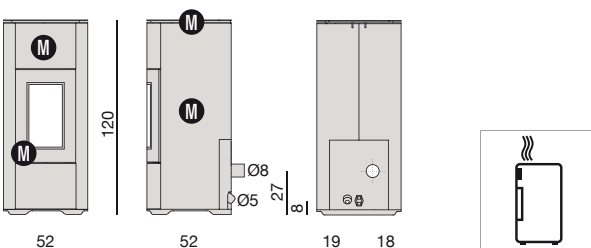

LOOP



LOOP



LOOP AIR 8 R

TOP CHOICE

Model: LOOP AIR 8 M2

POWER kW	%	cm	kg	kg/h	kg
8	92	8	130	0,6-1,8	21

core	maestro	easy connect	air	comfort air	comfort air	comfort air	no air	hydro
natural	oyster	free	matic	quick start	brush less	stove	pellet	ash pan
Wi-Fi	Wi-Fi	smartphone	control panel	pellet level sensor	ash pan	stove	pellet	ash pan

	4 STELLE D.M. 186				
--	-----------------------------	--	--	--	--

	CODE	£
LOOP AIR 8 R	7122094	2794.18

	Maestro smartphone app (free download)	
	Control panel "Lift" that integrates the ordinary functionalities with those of the emergency panel	
	Temperature probe	
	Maestro+ FREESTANDING thermostatic remote control Remote control with ambient thermostat and humidity sensor for room temperature control, always visible thanks to the e-ink display	4022002 269.85
	LIGHT Maestro+ thermostatic remote control unit Small dimensions and stove control with only two buttons. 3 preset modes: manual, automatic, comfort. Bluetooth connection. Compatible only with Maestro+ stoves, not compatible with hydro stoves	4024002 81.90
	Pellet level sensor	4018005 115.50
	Black "ECO" ash pan	4017019 48.30

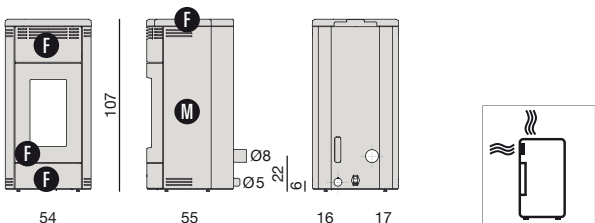

STOVES WITH SMOKE OUTLET REAR or UP/XUP

<p>Eiko R · Eiko UP / p. 18</p>  <p>REAR </p> <p>UP </p>	<p>Ego R · Ego UP · Ego XUP / p. 24</p>  <p>REAR </p> <p>UP </p> <p>XUP </p>	<p>Star R · Star UP / p. 28</p>  <p>REAR </p> <p>UP </p>
<p>Musa R · Musa UP / p. 32</p>  <p>REAR </p> <p>UP </p>	<p>Club R · Club UP / p. 36</p>  <p>REAR </p> <p>UP </p>	<p>Suite R · Suite UP / p. 42</p>  <p>REAR </p> <p>UP </p>
<p>Decò R/UP / p. 46</p>  <p>REAR </p> <p>UP </p>	<p>Cute R/UP / p. 47</p>  <p>REAR </p> <p>UP </p>	<p>Feel R · Feel UP / p. 48</p>  <p>REAR </p> <p>UP </p>
<p>Ray R · Ray UP · Ray XUP / p. 50</p>  <p>REAR </p> <p>UP </p> <p>XUP </p>	<p>Doc R · Doc UP / p. 56</p>  <p>REAR </p> <p>UP </p>	<p>Halo R · Halo UP / p. 62</p>  <p>REAR </p> <p>UP </p> <p>XUP </p>

PELLET STOVES_Air/Comfort Air Easy

- 70 ALEA > Air
- 62 GHEA > Air
- 74 HERA > Air
- 68 MAY > Air
- 64 MIDA > Air
- 72 RAAM > Comfort Air
- 66 TEIA > Comfort Air

GHEA



	CODE	£
GHEA AIR 6 R	7122014	1766.69
GHEA AIR 6 XUP	7122013	2168.63

	302 White metal	6922008	109.03
	308 Dark metal	6922006	109.03
	313 Silver metal	6922007	109.03

Accessories

	Temperature probe		
--	-------------------	--	--

Remote control

	Remote control	4015012	60.90
	Kit Wi-Fi Easy Connect For remote connection via the app. To be installed on the back of the stove, self-powered. Compatible with a 2.4 GHz frequency Wi-Fi router.	4020003	92.40
	Adapter for coaxial flues only for XUP stoves mm 80/130 » 80/125	4019014	60.90

GHEA AIR 6 R

TOP CHOICE

Model: GHEA AIR 6 S1

POWER kW					
6,3	96,9	8/13	100	0,5-1,4	17

	4 STELLE DIM 186			
--	---------------------	--	--	--

GHEA AIR 6 XUP

Model: GHEA AIR 6 XUP! S1

POWER kW					
6,3	96,9	8/13	103	0,5-1,4	13

	4 STELLE DIM 186			
--	---------------------	--	--	--

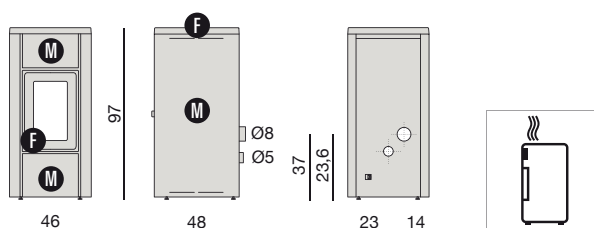



MIDA



MIDA



302



308



313



304

MIDA AIR 8 R

TOP CHOICE

Model: MIDA AIR 8 S1

POWER kW	%	cm	kg	kg/h	kg
8,2	96,9	8/13	105	0,5-1,9	14

core	maestro	easy connect	air	comfort air	comfort air	comfort air	no air	hydro
natural	oyster	free	matic	quick start	brush less	no air	hydro	hydro
kit wi-fi	kit wi-fi	kit wi-fi	kit wi-fi	kit wi-fi	kit wi-fi	kit wi-fi	kit wi-fi	kit wi-fi

4 STELLE DM 186	7*
-----------------	----

MIDA AIR 8 XUP

Model: MIDA AIR 8 XUP! S1

POWER kW	%	cm	kg	kg/h	kg
8,2	96,9	8/13	105	0,5-1,9	14

core	maestro	easy connect	air	comfort air	comfort air	comfort air	no air	hydro
natural	oyster	free	matic	quick start	brush less	no air	hydro	hydro
kit wi-fi	kit wi-fi	kit wi-fi	kit wi-fi	kit wi-fi	kit wi-fi	kit wi-fi	kit wi-fi	kit wi-fi

4 STELLE DM 186	7*
-----------------	----

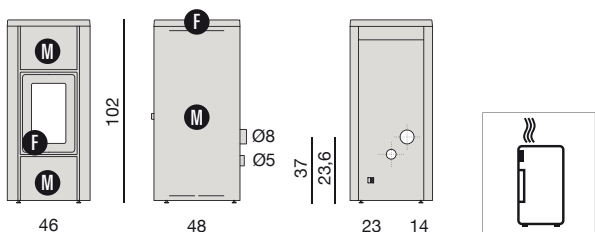

	CODE	£
MIDA AIR 8 R	7122016	1865.56
MIDA AIR 8 XUP	7122015	2259.18

302 White metal	6922012	113.66
308 Dark metal	6922010	113.66
313 Silver metal	6922011	113.66

°C	Temperature probe	

	Remote control	4015012 60.90
	Kit Wi-Fi Easy Connect For remote connection via the app. To be installed on the back of the stove, self-powered. Compatible with a 2.4 GHz frequency Wi-Fi router.	4020003 92.40
	Adapter for coaxial flues only for XUP stoves mm 80/130 » 80/125	4019014 60.90

TEIA



	CODE	£
TEIA C.AIR 10 R	7122062	2206.51
TEIA C.AIR 10 UP	7122063	2453.22

	308 Dark metal	6922014	198.66
	302 White metal	6922015	198.66
	304 Bordeaux metal	6922016	198.66

	Temperature probe		
--	-------------------	--	--

	Remote control	4015012	60.90
	Kit Wi-Fi Easy Connect For remote connection via the app. To be installed on the back of the stove, self-powered. Compatible with a 2.4 GHz frequency Wi-Fi router.	4020003	92.40
	Black "LOW" ash pan	4017018	73.50

>>> Comfort Air® accessories
To build a Comfort Air® channelling system
> PELLET_Accessories

TEIA C.AIR 10 R

TOP CHOICE

Model: TEIA COMFORT AIR 10 S2

POWER kW					
10	91,5	8	132	0,8-2,3	27

	4 STELLE D.M. 186				
--	-----------------------------	--	--	--	--

TEIA C.AIR 10 UP

Model: TEIA COMFORT AIR 10 UP! S2

POWER kW					
10	91,5	8	135	0,8-2,3	25

	4 STELLE D.M. 186				
--	-----------------------------	--	--	--	--

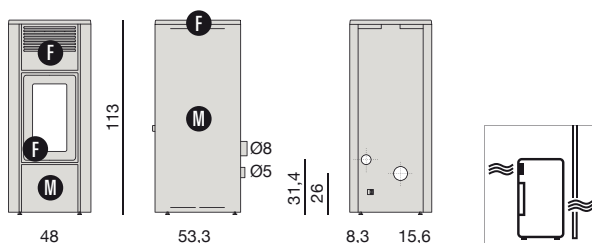





MAY

MAY AIR 7 R 5S

NEW **TOP CHOICE**

Model: MAY AIR 7 S2 5S

POWER kW	%	cm	kg	kg/h	kg
6,2	92	8	102	0,6/1,4	17

core	maestro	easy connect	air	comfort air	comfort air	comfort air	no air	hydro
natural	oyster	free	matic	quick start	calendar	brush less	stove	water tap
kit wi-fi	touch	control panel	control panel	control panel	control panel	control panel	control panel	control panel

A	5 STELLE D.M. 186	CONTO TERMICO	Flame 7*		
---	-----------------------------	---------------	-----------------	--	--

	CODE	£
MAY AIR 7 R 5S	7124051	1888.95

	308 Dark metal	6920001	183.75
	302 White metal	6920002	183.75
	304 Bordeaux metal	6920003	183.75
	313 Silver metal	6920004	183.75

Temperature probe	
	Temperature probe

Remote control		
	Remote control	
	4015012	60.90

Kit Wi-Fi Easy Connect		
	Kit Wi-Fi Easy Connect	
For remote connection via the app. To be installed on the back of the stove, self-powered. Compatible with a 2.4 GHz frequency Wi-Fi router.		
	4020003	92.40

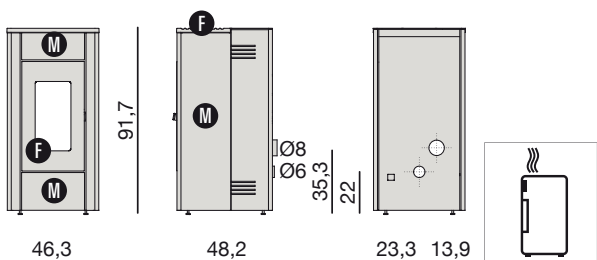

ALEA



ALEA



ALEA AIR 7 R

TOP CHOICE

Model: ALEA AIR 7 S1

POWER kW	%	cm	kg	kg/h	kg
7	93,1	8	80	0,6-1,7	12

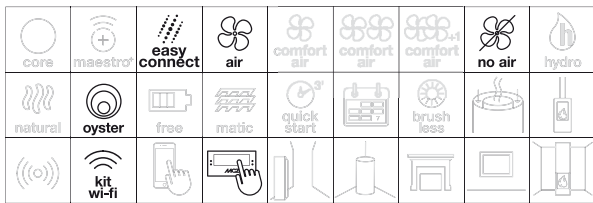

ALEA AIR 7 XUP

Model: ALEA AIR 7 S1 XUP!

POWER kW	%	cm	kg	kg/h	kg
7	93,1	8/13	80	0,6-1,7	12

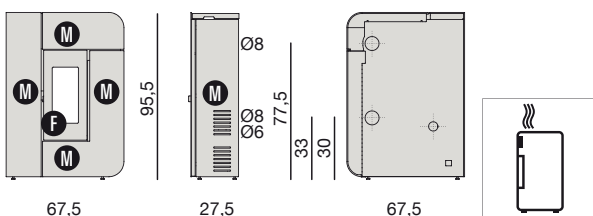
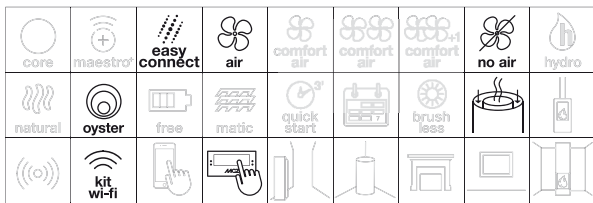

	CODE	£
ALEA AIR 7 R	7121060	1903.44
ALEA AIR 7 XUP	7121059	2824.50

	308 Dark metal	6921042	165.40
	302 White metal	6921040	165.40
	304 Bordeaux metal	6921043	165.40
	313 Silver metal	6921041	165.40

	Temperature probe		
--	-------------------	--	--

	Pipes required for installation: 90° Curve Only for "R" stoves Painted curve with silicone gasket for installation with rear smoke outlet. Ø cm 8	4022008	43.05
--	--	---------	-------

	Remote control	4015012	60.90
--	----------------	---------	-------

	Kit Wi-Fi Easy Connect For remote connection via the app. To be installed on the back of the stove, self-powered. Compatible with a 2.4 GHz frequency Wi-Fi router.	4020003	92.40
--	--	---------	-------

	Adapter for coaxial flues only for XUP stoves mm 80/130 » 80/125	4019014	60.90
--	---	---------	-------

RAAM

RAAM C.AIR 8 R

Model: RAAM COMFORT AIR 8 S2

POWER kW	%	cm	kg	kg/h	kg
7,8	90,2	8	155	0,8-1,8	18

core	maestro	easy connect	air	comfort air	comfort air	comfort air	no air	hydro
natural	oyster	free	matic	quick start	brush less	no air	hydro	hydro
kit wi-fi	kit wi-fi	kit wi-fi	kit wi-fi	kit wi-fi	kit wi-fi	kit wi-fi	kit wi-fi	kit wi-fi

A G	4 STELLE D.M. 186	CONTO TERMICO	<i>flamme 7+</i>		
-----	-----------------------------	---------------	------------------	--	--

RAAM C.AIR 8 UP

Model: RAAM COMFORT AIR 8 UP1 S2

POWER kW	%	cm	kg	kg/h	kg
7,8	90,2	8	155	0,8-1,8	18

core	maestro	easy connect	air	comfort air	comfort air	comfort air	no air	hydro
natural	oyster	free	matic	quick start	brush less	no air	hydro	hydro
kit wi-fi	kit wi-fi	kit wi-fi	kit wi-fi	kit wi-fi	kit wi-fi	kit wi-fi	kit wi-fi	kit wi-fi

A G	4 STELLE D.M. 186	CONTO TERMICO	<i>flamme 7+</i>		
-----	-----------------------------	---------------	------------------	--	--

	CODE	£
RAAM C.AIR 8 R	7122067	2647.26
RAAM C.AIR 8 UP	7124008	3409.35

	302 White metal	6918005	303.07
	308 Dark metal	6918006	303.07
	313 Silver metal	6918007	303.07
	304 Bordeaux metal	6918008	303.07

	Temperature probe		
--	-------------------	--	--

	Remote control	4015012	60.90
--	----------------	---------	-------

	Kit Wi-Fi Easy Connect For remote connection via the app. To be installed on the back of the stove, self-powered. Compatible with a 2.4 GHz frequency Wi-Fi router.	4020003	92.40
--	--	---------	-------

	Comfort Air® accessories To build a Comfort Air® channelling system > PELLET_Accessories		
--	--	--	--

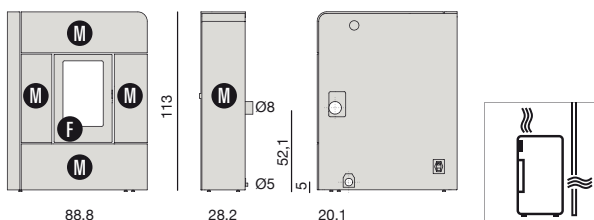



HERA



HERA AIR 8 XUP TOP CHOICE

Model: HERA AIR 8 XUP! S1

POWER kW	%	cm	kg	kg/h	kg
8,2	96,9	8/13	80	0,5-1,9	18

core	maestro	easy connect	air	comfort air	comfort air	comfort air	no air	hydro
natural	oyster	free	matic	quick start	brush less	stove	stove	stove
kit wi-fi	kit wi-fi	kit wi-fi	kit wi-fi	kit wi-fi	kit wi-fi	kit wi-fi	kit wi-fi	kit wi-fi

A	4 STELLE D.M. 186	CONTO TERMICO	Flame 7+		
---	-----------------------------	---------------	----------	--	--

	CODE	£
HERA AIR 8 XUP	7122077	2292.45

308 Dark metal	6921013	133.06
302 White metal	6921011	146.92
305 Bronze metal	6921010	151.54
313 Silver metal	6921012	146.92

Accessories

°C	Temperature probe		
----	-------------------	--	--

Accessories

	Remote control	4015012	60.90
--	----------------	---------	-------

	Kit Wi-Fi Easy Connect For remote connection via the app. To be installed on the back of the stove, self-powered. Compatible with a 2.4 GHz frequency Wi-Fi router.	4020003	92.40
--	---	---------	-------

	Adapter for coaxial flues only for XUP stoves mm 80/130 » 80/125	4019014	60.90
--	---	---------	-------

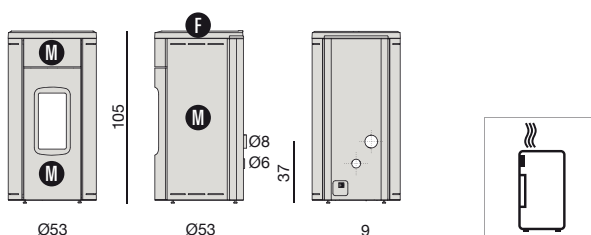



STOVES WITH SMOKE OUTLET REAR or UP/XUP

<p>Ghea R · Ghea XUP / p. 74</p>  <p>REAR </p> <p>XUP </p>	<p>Mida R · Mida XUP / p. 76</p>  <p>REAR </p> <p>XUP </p>	<p>Teia R · Teia UP / p. 78</p>  <p>REAR </p> <p>UP </p>
<p>Alea R · Alea XUP / p. 82</p>  <p>REAR </p> <p>XUP </p>	<p>Raam R · Raam UP / p. 84</p>  <p>REAR </p> <p>UP </p>	<p>Hera R · Hera XUP / p. 86</p>  <p>REAR </p> <p>XUP </p>

PELLET STOVES_Hydro Maestro

- 84 AKI > Hydromatic
- 82 CLUB > Hydromatic
- 78 EGO > Hydromatic
- 80 MUSA > Hydromatic
- 86 PAD > Hydromatic
- 83 SUITE > Hydromatic

EGO



EGO
Hydromatic



MUSA
Hydromatic



CLUB
CLUB ABSOLUTE
Hydromatic



SUITE
Hydromatic

EGO



302



308



313



304

EGO HYDRO MATIC 8 R

NEW

Model: EGO HYDROMATIC 8 M3

POWER kW 8 (6 H ₂ O)	 93,1	 8 cm	 138 kg	 0,9/1,8 kg/h	 20 kg			
core	maestro	easy connect	air	comfort air	comfort air	comfort air	no air	hydro
natural	oyster	free	matic	quick start	brush less	no brush	no brush	no brush
kit wi-fi	kit wi-fi	kit wi-fi	kit wi-fi	kit wi-fi	kit wi-fi	kit wi-fi	kit wi-fi	kit wi-fi

EGO HYDRO MATIC 12 R

NEW

Model: EGO HYDROMATIC 12 M3

POWER kW 12,1 (9,4 H ₂ O)	 93,1	 8 cm	 137 kg	 0,9/2,8 kg/h	 20 kg			
core	maestro	easy connect	air	comfort air	comfort air	comfort air	no air	hydro
natural	oyster	free	matic	quick start	brush less	no brush	no brush	no brush
kit wi-fi	kit wi-fi	kit wi-fi	kit wi-fi	kit wi-fi	kit wi-fi	kit wi-fi	kit wi-fi	kit wi-fi

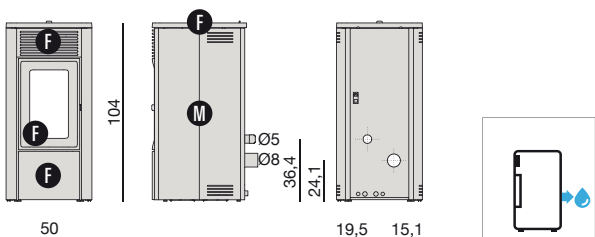

	CODE	£
EGO HYDRO MATIC 8 R	7122079	3187.80
EGO HYDRO MATIC 12 R	7122080	3418.22

	302 White metal	6921001	269.81
	308 Dark metal	6921002	269.81
	313 Silver metal	6921003	269.81
	304 Bordeaux metal	6921004	269.81

Maestro smartphone app (free download)

Control panel "Lift" that integrates the ordinary functionalities with those of the emergency panel

Temperature probe

Maestro+ FREESTANDING thermostatic remote control 4022002 269.85
Remote control with ambient thermostat and humidity sensor for room temperature control, always visible thanks to the e-ink display

Pellet level sensor 4018005 115.50

Pressure gauge 4018035 55.65

NTC probe 4012062 31.50
Temperature probe
Cable length 1500 mm

Thermostatic valve kit 40A18011 282.45
The valve is needed to prevent the return of cold water from the system to the boiler and therefore it avoids the danger of condensation. It is calibrated at 45 °C. In the price copper connecting pipes are included.

MUSA



MUSA



	CODE	£
MUSA HYDRO MATIC 18 R	7121039	3445.08
MUSA HYDRO MATIC 24 R	7121040	3942.31

	302 White metal	6921026	363.83
	308 Dark metal	6921027	363.83
	313 Silver metal	6921028	363.83
	304 Bordeaux metal	6921029	363.83

	Maestro smartphone app (free download)		
	Control panel "Lift" that integrates the ordinary functionalities with those of the emergency panel		
	Temperature probe		

	Maestro+ FREESTANDING thermostatic remote control Remote control with ambient thermostat and humidity sensor for room temperature control, always visible thanks to the e-ink display	4022002	269.85
	Pellet level sensor	4018005	115.50
	Pressure gauge	4018035	55.65
	NTC probe Temperature probe Cable length 1500 mm	4012062	31.50
	Thermostatic valve kit The valve is needed to prevent the return of cold water from the system to the boiler and therefore it avoids the danger of condensation. It is calibrated at 45 °C. In the price copper connecting pipes are included.	40A18011	282.45

MUSA HYDRO MATIC 18 R

Model: MUSA HYDROMATIC 18 M2

POWER kW					
17,7 (12,7 H ₂ O)	95,9	8	197	1-3,9	26
	5 STELLE D.M. 186				

MUSA HYDRO MATIC 24 R

Model: MUSA HYDROMATIC 24 M2

POWER kW					
24,2 (18,2 H ₂ O)	95,9	8	197	1-5,4	26
	5 STELLE D.M. 186				

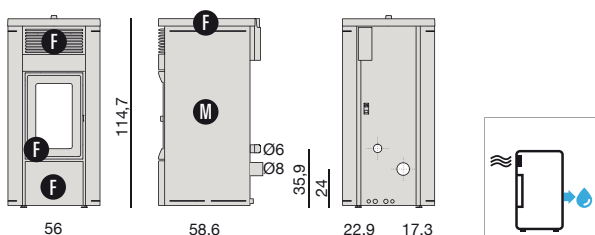

CLUB



102



126



109



105

	CODE	£
CLUB HYDRO MATIC 18 R	7121027	3587.15
CLUB HYDRO MATIC 24 R	7121029	4115.56

	102 White ceramic	6921018	595.12
	126 Matt Black ceramic	6921020	595.12
	109 Sand ceramic	6921021	595.12
	105 Bordeaux ceramic	6921019	595.12

	Maestro smartphone app (free download)		
	Control panel "Lift" that integrates the ordinary functionalities with those of the emergency panel		
	Temperature probe		

CLUB HYDRO MATIC 18 R

Model: CLUB HYDROMATIC 18 M2

POWER kW					
17,7 (12,7 H ₂ O)	95,9	8	197	1-3,9	26

5 STELLE D.M. 186

CLUB HYDRO MATIC 24 R

Model: CLUB HYDROMATIC 24 M2

POWER kW					
24,2 (18,2 H ₂ O)	95,9	8	197	1-5,4	26

5 STELLE D.M. 186

	Maestro+ FREESTANDING thermostatic remote control Remote control with ambient thermostat and humidity sensor for room temperature control, always visible thanks to the e-ink display	4022002	269.95
	Pellet level sensor	4018005	115.50
	Pressure gauge	4018035	55.65
	NTC probe Temperature probe Cable length 1500 mm	4012062	31.50
	Thermostatic valve kit The valve is needed to prevent the return of cold water from the system to the boiler and therefore it avoids the danger of condensation. It is calibrated at 45 °C. In the price copper connecting pipes are included.	40A18011	282.45

CLUB CERAMIC

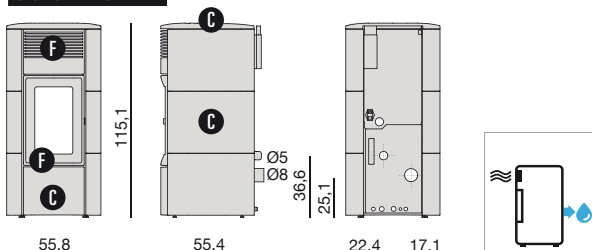

SUITE



113



105



126



110

SUITE HYDRO MATIC 18 R

Model: SUITE HYDROMATIC 18 M2

POWER kW	%	cm	kg	kg/h	kg
17,7 (12,7 H ₂ O)	95,9	8	197	1-3,9	26

core	maestro	easy connect	air	comfort air	comfort air	comfort air	no air	hydro
natural	oyster	free	matic	quick start	brush less	no brush	no ash	no ash
kit wi-fi	kit wi-fi	kit wi-fi	kit wi-fi	kit wi-fi	kit wi-fi	kit wi-fi	kit wi-fi	kit wi-fi

5 STELLE D.M. 186

SUITE HYDRO MATIC 24 R

Model: SUITE HYDROMATIC 24 M2

POWER kW	%	cm	kg	kg/h	kg
24,2 (18,2 H ₂ O)	95,9	8	197	1-5,4	26

core	maestro	easy connect	air	comfort air	comfort air	comfort air	no air	hydro
natural	oyster	free	matic	quick start	brush less	no brush	no ash	no ash
kit wi-fi	kit wi-fi	kit wi-fi	kit wi-fi	kit wi-fi	kit wi-fi	kit wi-fi	kit wi-fi	kit wi-fi

5 STELLE D.M. 186

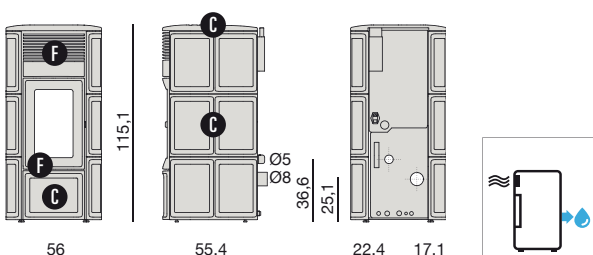

	CODE	£
SUITE HYDRO MATIC 18 R	7121027	3587.15
SUITE HYDRO MATIC 24 R	7121029	4115.56

	113 Warm Grey ceramic	6921017	595.12
	105 Bordeaux ceramic	6921015	595.12
	126 Matt Black ceramic	6921016	595.12
	110 Salt and pepper ceramic	6921014	595.12

	Maestro smartphone app (free download)		
	Control panel "Lift" that integrates the ordinary functionalities with those of the emergency panel		
	Temperature probe		

	Maestro+ FREESTANDING thermostatic remote control Remote control with ambient thermostat and humidity sensor for room temperature control, always visible thanks to the e-ink display	4022002	269.85
	Pellet level sensor	4018005	115.50
	Pressure gauge	4018035	55.65
	NTC probe Temperature probe Cable length 1500 mm	4012062	31.50
	Thermostatic valve kit The valve is needed to prevent the return of cold water from the system to the boiler and therefore it avoids the danger of condensation. It is calibrated at 45 °C. In the price copper connecting pipes are included.	40A18011	282.45

AKI

AKI HYDRO MATIC 18 R

Model: AKI HYDROMATIC 18 M2

POWER kW					
17,7 (12,7 H ₂ O)	95,9	8	190	1-3,9	28

natural	oyster	free	matic	quick start	brush less			



AKI HYDRO MATIC 24 R

Model: AKI HYDROMATIC 24 M2

POWER kW					
24,2 (18,2 H ₂ O)	95,9	8	190	1-5,4	28

natural	oyster	free	matic	quick start	brush less			



	CODE	£
AKI HYDRO MATIC 18 R	7121045	4053.19
AKI HYDRO MATIC 24 R	7121046	4439.54

	CODE	£
302 White metal	6920026	244.28
308 Dark metal	6920025	244.28
313 Silver metal	6920027	244.28
102 White ceramic	6920028	470.38
105 Bordeaux ceramic	6920029	470.38
109 Sand ceramic	6920030	470.38

maestro

	Maestro smartphone app (free download)
	Control panel "Lift" that integrates the ordinary functionalities with those of the emergency panel
	Temperature probe

PIPES REQUIRED FOR INSTALLATION

	PIPES REQUIRED FOR INSTALLATION Linear pipe Ø cm 8 Painted pipe 100 cm with silicone gasket for vertical smoke outlet installation	4022007	44.10
	PIPES REQUIRED FOR INSTALLATION 90° Curve Ø cm 8 Painted curve with silicone gasket for rear smoke outlet installation	4022008	38.85
	Maestro+ FREESTANDING thermostatic remote control Remote control with ambient thermostat and humidity sensor for room temperature control, always visible thanks to the e-ink display	4022002	245.70
	Pellet level sensor	4018005	115.50
	Pressure gauge	4018035	55.65
	NTC probe Temperature probe Cable length 1500 mm	4012062	31.50
	Thermostatic valve kit The valve is needed to prevent the return of cold water from the system to the boiler and therefore it avoids the danger of condensation. It is calibrated at 45 °C. In the price copper connecting pipes are included.	40A18011	282.45

AKI CERAMIC

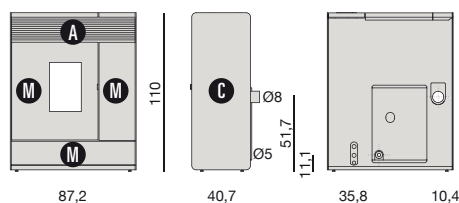

AKI METAL

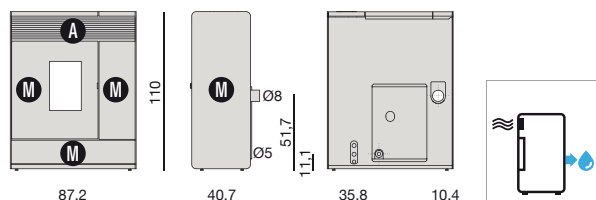



PAD



PAD



	CODE	£
PAD HYDRO MATIC 18 R	7121030	3871.28
PAD HYDRO MATIC 24 R	7121031	4372.83

	102 Plain White ceramic	6921025	563.93
	107 Plain Black ceramic	6921024	563.93
	102 Line White ceramic	6921023	563.93
	105 Line Bordeaux ceramic	6921022	563.93

	Maestro smartphone app (free download)		
	Control panel "Lift" that integrates the ordinary functionalities with those of the emergency panel		
	Temperature probe		

	Maestro+ FREESTANDING thermostatic remote control Remote control with ambient thermostat and humidity sensor for room temperature control, always visible thanks to the e-ink display	4022002	269.85
--	--	---------	--------

	Pellet level sensor	4018005	115.50
--	---------------------	---------	--------

	Pressure gauge	4018035	55.65
--	----------------	---------	-------

	NTC probe Temperature probe Cable length 1500 mm	4012062	31.50
--	--	---------	-------

	Thermostatic valve kit The valve is needed to prevent the return of cold water from the system to the boiler and therefore it avoids the danger of condensation. It is calibrated at 45 °C. In the price copper connecting pipes are included.	40A18011	282.45
--	---	----------	--------

PAD HYDRO MATIC 18 R

Model: PAD PLAIN HYDROMATIC 18 M2 / PAD LINE HYDROMATIC 18 M2

POWER kW					
17,7 (12,7 H ₂ O)	95,9	8	190	1-3,9	26

--	--	--	--	--

PAD HYDRO MATIC 24 R

Model: PAD PLAIN HYDROMATIC 24 M2 / PAD LINE HYDROMATIC 24 M2

POWER kW					
24,2 (18,2 H ₂ O)	95,9	8	190	1-5,4	26

--	--	--	--	--

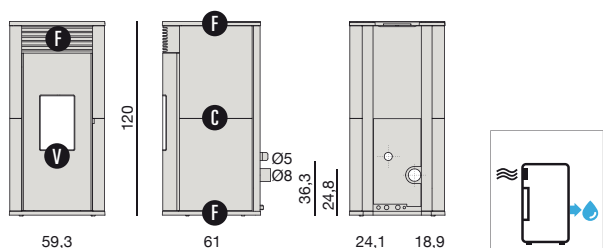

PELLET_Fireplaces and inserts

95 QBOX 60 > AIR

97 QBOX 70 > AIR

90 VIVO 90-9 > COMFORT AIR

92 VIVO 90-11 > COMFORT AIR

99 VIVO 90 > HYDRO

VIVO 90 - 9

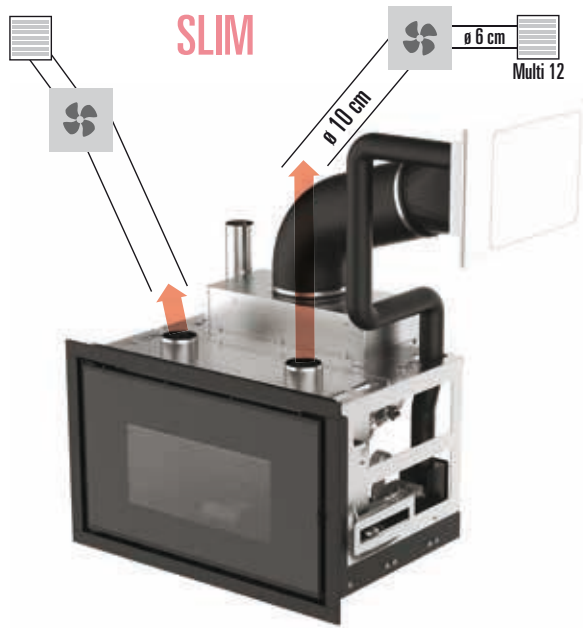

VIVO 90 C.AIR 9

NEW

Model: VIVO 90 COMFORT AIR 9 M1

POWER kW	%	cm	kg	kg/h	kg
8,9	95,7	8	180	0,6-2	23

core	maestro	easy connect	air	comfort air	comfort air	comfort air	no air	hydro
natural	oyster	free	matic	quick start	brush less	stove	pellet	hydro
Wi-Fi	Wi-Fi	Wi-Fi	Wi-Fi	Wi-Fi	Wi-Fi	Wi-Fi	Wi-Fi	Wi-Fi

A	4 STELLE D.M. 186	CONTO TERMICO	Flame 7+		
---	-----------------------------	---------------	----------	--	--

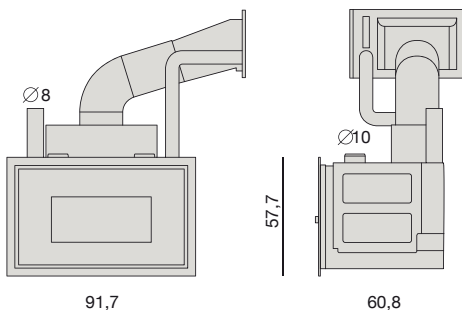

	CODE	£
VIVO 90 C.AIR 9	5022004	3788.40
SLIM Comfort Air® kit -2 x Multi 12 outlets -2 x ø 10 cm - L=1.5 m pipes -2 x ø 6 cm pipes -Motor inspection hatches -2 fan units -2 x ø 60 mm clamps -2 x ø 100 mm clamps	4012008	589.51
TOTAL		5472.39

Accessories

maestro	Maestro smartphone app (free download)		
°C	Temperature probe		
	Passe-partout frame 4 sides Included: "Blade" convection grille 99x6,1 cm. Pellet feed pipe with door		
	Maestro+ FREESTANDING thermostatic remote control Remote control with ambient thermostat and humidity sensor for room temperature control, always visible thanks to the e-ink display	4022002	269.85
	LIGHT Maestro+ thermostatic remote control unit Small dimensions and stove control with only two buttons. 3 preset modes: manual, automatic, comfort. Bluetooth connection. Compatible only with Maestro+ stoves, not compatible with hydro stoves	4024002	81.90
	Pellet level sensor	4018005	115.50
	Support	4014001	312.90
	FLIP ventilation outlet - White glass	4012017	312.90
	GHOST ventilation outlet White glass Black glass	4012020 4012021	330.75 330.75
	MINIMAL ventilation outlet - Metal can be painted	4017009	256.20
	SOFT ventilation outlet - Ceramic	4017010	281.40
	Comfort Air® accessories To build a Comfort Air® channelling system > PELLETS_Accessories		

VIVO 90 - 9

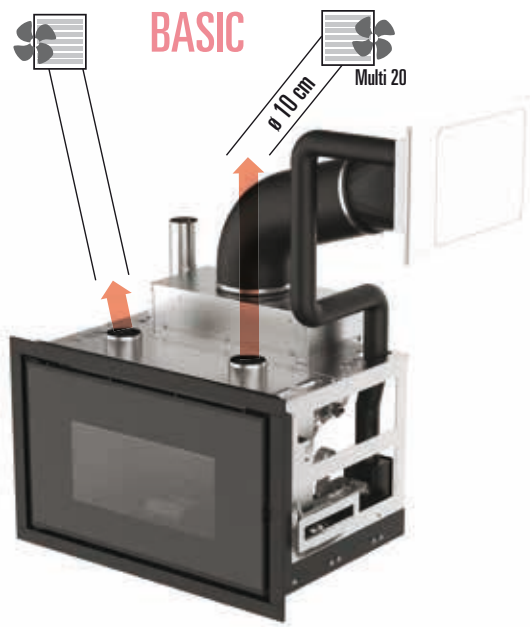

VIVO 90 C.AIR 9 NEW

Model: VIVO 90 COMFORT AIR 9 M1

POWER kW	%	cm	kg	kg/h	kg
8,9	95,7	8	180	0,6-2	23

core	maestro	easy connect	air	comfort air	comfort air	comfort air	no air	hydro
natural	oyster	free	matic	quick start	brush less	no air	hydro	hydro
wi-fi	wi-fi	wi-fi	wi-fi	wi-fi	wi-fi	wi-fi	wi-fi	wi-fi

A	4 STELLE D.M. 186	CONTO TERMICO	flame 7*		
---	-----------------------------	---------------	----------	--	--

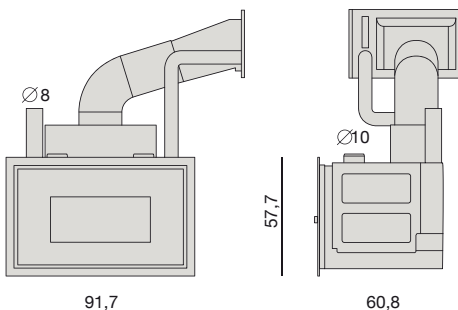

	CODE	£
VIVO 90 C.AIR 9	5022004	3788.40
BASIC Comfort Air® kit -2 x Multi 20 outlets -2 x ø 10 cm - L=1.5 m pipes -2 fan units -4 clamps -2 brackets	4012007	363.14
TOTAL		5189.42

maestro	Maestro smartphone app (free download)
°C	Temperature probe
	Pass-partout frame 4 sides Included: "Blade" convection grille 99x6,1 cm. Pellet feed pipe with door

	Maestro+ FREESTANDING thermostatic remote control Remote control with ambient thermostat and humidity sensor for room temperature control, always visible thanks to the e-ink display	4022002	269.85
	LIGHT Maestro+ thermostatic remote control unit Small dimensions and stove control with only two buttons. 3 preset modes: manual, automatic, comfort. Bluetooth connection. Compatible only with Maestro+ stoves, not compatible with hydro stoves	4024002	81.90
	Pellet level sensor	4018005	115.50
	Support	4014001	312.90
	MONO 20 Mono-directional air outlet with humidifier Without light With light*	4008021 4008023	135.45 312.90
	BI 20 Bi-directional air outlet	4008024	115.50
	Comfort Air® accessories To build a Comfort Air® channelling system > PELLETS_Accessories		

VIVO 90 - 11



VIVO 90 C.AIR 11

NEW

Model: VIVO 90 COMFORT AIR 11 M1

POWER kW	%	cm	kg	kg/h	kg
10,9	95,7	8	180	0,6-2,5	23

core	maestro	easy connect	air	comfort air	comfort air	comfort air	no air	hydro
natural	oyster	free	matic	quick start	brush less	pellet	stove	stove
Wi-Fi	Wi-Fi	Wi-Fi	Wi-Fi	Wi-Fi	Wi-Fi	Wi-Fi	Wi-Fi	Wi-Fi

A	4 STELLE D.M. 186	CONTO TERMICO	Flame 7+		
---	-----------------------------	---------------	----------	--	--

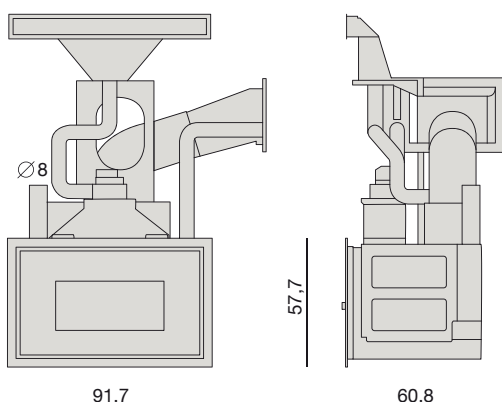

	CODE	£
VIVO 90 C.AIR 11	5022005	4243.01
SLIM Comfort Air® kit -2 x Multi 12 outlets -2 x ø 10 cm - L=1.5 m pipes -2 x ø 6 cm pipes -Motor inspection hatches -2 fan units -2 x ø 60 mm clamps -2 x ø 100 mm clamps	4012008	589.51
TOTAL		5305.65

	Maestro smartphone app (free download)	
	Temperature probe	
	Passe-partout frame 4 sides Included: "Blade" convection grille 99x6,1 cm. Pellet feed pipe with door	
	Upper hot air outlet nozzle 90x11 cm	
	Maestro+ FREESTANDING thermostatic remote control Remote control with ambient thermostat and humidity sensor for room temperature control, always visible thanks to the e-ink display	4022002 269.95
	LIGHT Maestro+ thermostatic remote control unit Small dimensions and stove control with only two buttons. 3 preset modes: manual, automatic, comfort. Bluetooth connection. Compatible only with Maestro+ stoves, not compatible with hydro stoves	4024002 81.90
	Pellet level sensor	4018005 115.50
	Support	4014001 312.90
	FLIP ventilation outlet - White glass	4012017 312.90
	GHOST ventilation outlet White glass Black glass	4012020 330.75 4012021 330.75
	MINIMAL ventilation outlet - Metal can be painted	4017009 256.20
	SOFT ventilation outlet - Ceramic	4017010 281.40
	Comfort Air® accessories To build a Comfort Air® channelling system > PELLET_Accessories	

VIVO 90 - 11



VIVO 90 C.AIR 11

NEW

Model: VIVO 90 COMFORT AIR 11 M1

POWER kW	%	cm	kg	kg/h	kg
10,9	95,7	8	180	0,6-2,5	23

core	maestro	easy connect	air	comfort air	comfort air	comfort air	no air	hydro
natural	oyster	free	matic	quick start	brush less	no air	hydro	hydro
Wi-Fi	Wi-Fi	Wi-Fi	Wi-Fi	Wi-Fi	Wi-Fi	Wi-Fi	Wi-Fi	Wi-Fi

A	4 STELLE D.M. 186	CONTO TERMICO	flame 7*		
---	-----------------------------	---------------	----------	--	--

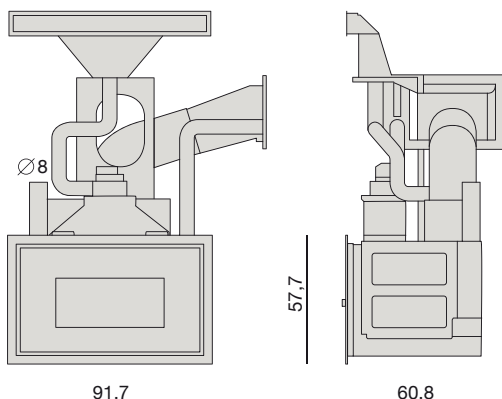

	CODE	£
VIVO 90 C.AIR 11	5022005	4243.01
BASIC Comfort Air® kit -2 x Multi 20 outlets -2 x ø 10 cm - L=1.5 m pipes -2 fan units -4 clamps -2 brackets	4012007	363.14
TOTAL		5757.68

	Maestro smartphone app (free download)		
	Temperature probe		
	Passerelle frame 4 sides Included: "Blade" convection grille 99x6,1 cm. Pellet feed pipe with door		
	Upper hot air outlet nozzle 90x11 cm		
	Maestro+ FREESTANDING thermostatic remote control Remote control with ambient thermostat and humidity sensor for room temperature control, always visible thanks to the e-ink display	4022002	269.85
	LIGHT Maestro+ thermostatic remote control unit Small dimensions and stove control with only two buttons. 3 preset modes: manual, automatic, comfort. Bluetooth connection. Compatible only with Maestro+ stoves, not compatible with hydro stoves	4024002	81.90
	Pellet level sensor	4018005	115.50
	Support	4014001	312.90
	MONO 20 Mono-directional air outlet with humidifier Without light With light*	4008021 4008023	135.45 312.90
	BI 20 Bi-directional air outlet	4008024	115.50
	Comfort Air® accessories To build a Comfort Air® channelling system > PELLET_Accessories		

VIVO 90



QBOX 60



CODE	£
QBOX 60 AIR 6	2642.64

Accessories

	Maestro smartphone app (free download)		
	Maestro+ FREESTANDING thermostatic remote control Remote control with ambient thermostat and humidity sensor for room temperature control, always visible thanks to the e-ink display		
	Temperature probe		
	Pellet level sensor		

Accessories

	Support	4012009	312.90
	Fourth bottom side to complete the frame Black	4023001	35.70

QBOX 60 AIR 6 NEW

Model: QBOX 60 AIR 6 M1

POWER kW					
6,1	92	8	100	0,7-1,4	8
	4 STELLE D.M. 186				

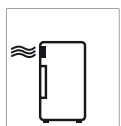
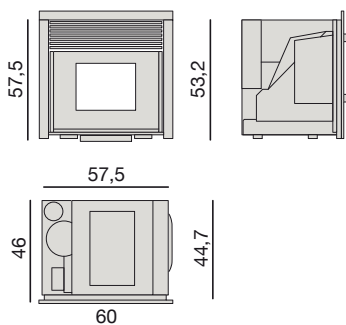

QBOX PELLET



QBOX 70



CODE	£
QBOX 70 AIR 8	2903.21

Accessories

	Maestro smartphone app (free download)
	Maestro+ FREESTANDING thermostatic remote control Remote control with ambient thermostat and humidity sensor for room temperature control, always visible thanks to the e-ink display
	Temperature probe
	Pellet level sensor

Support

	Support	4012009	312.90
	Fourth bottom side to complete the frame Black	4023002	35.70

QBOX 70 AIR 8 NEW

Model: QBOX 70 AIR 8 M1

POWER kW					
7,9	92	8	135	0,8-1,8	20
	4 STELLE D.M. 186				

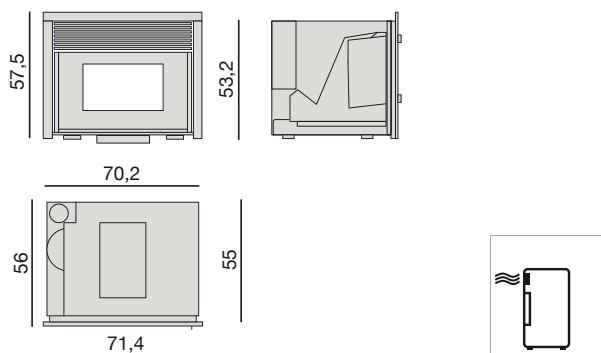

VIVO 90 HYDRO



VIVO 90 HYDRO



	CODE	£
VIVO 90 HYDRO 16	5020003	4053.19
VIVO 90 HYDRO 24	5020004	4266.29

	Maestro "upgrade" smartphone app (free download)
	Temperature probe
	Pellet feed pipe with door

	Freestanding remote control with room thermostat cm 5,4x6,5x19,5 H	4020006	135.45
	Maestro built-in panel cm 16,3x8,5	4021001	202.65
	Maestro wall-mounted panel cm 16,3x8,5	4021002	202.65
	Support	4014001	312.90
	Pellet level sensor	4018005	115.50
	Pressure gauge	4018035	50.40
	NTC probe Temperature probe Cable length 1500 mm	4012062	\$1.52

VIVO 90 HYDRO 16

Model: VIVO 90 HYDRO 16 M1

POWER kW					
18 (13 H ₂ O)	95,9	10	190	1,2-3,9	42

	4 STELLE D.M. 186				
--	-----------------------------	--	--	--	--

VIVO 90 HYDRO 24

Model: VIVO 90 HYDRO 24 M1

POWER kW					
24,7 (19 H ₂ O)	95,9	10	190	1,2-5,5	42

	4 STELLE D.M. 186				
--	-----------------------------	--	--	--	--

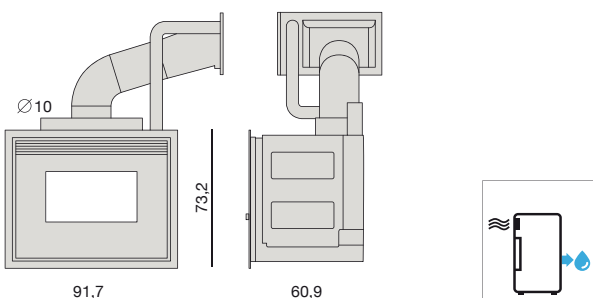

WOOD_Fireplaces and inserts

- 102 PLASMA 115 WOOD > Natural/Comfort Air
- 103 PLASMA 95 WOOD > Natural/Comfort Air
- 104 PLASMA 85 WOOD > Natural/Comfort Air
- 105 PLASMA 75 WOOD > Natural/Comfort Air
- 106 PLASMA 95 DX/SX WOOD > Natural/Comfort Air
- 107 PLASMA 75 DX/SX WOOD > Natural/Comfort Air
- 108 PLASMA 115B WOOD > Natural/Comfort Air
- 109 PLASMA B95 WOOD > Natural/Comfort Air
- 110 PLASMA 95T WOOD > Natural/Comfort Air
- 111 PLASMA T50 WOOD > Natural/Comfort Air
- 112 VIVO 90Q WOOD > Natural/Comfort Air
- 113 VIVO 70Q WOOD > Natural/Comfort Air
- 114 QBOX 100 WOOD > Air
- 115 QBOX 80 WOOD > Air
- 116 QBOX 70 WOOD > Air
- 117 QBOX 60 WOOD > Air
- 119 STONE CASE > Air
- 121 STEEL CASE > Air

PLASMA 115 WOOD



PLASMA 115 WOOD

Model: PLASMA 115 WOOD

POWER kW	%	cm	kg	cm A x B x C
14,1	80,1	20	384	128 x 54 x 140,6

air	comfort air	natural	easy switch	easy going			
-----	-------------	---------	-------------	------------	--	--	--

--	--	--

	CODE	£
PLASMA 115 WOOD	5017001	3821.66

	Passe-partout Painted black steel_303. It can be used as a minimal frame in the case of plasterboard cladding.	620217 308.62
	Additional weights kit Additional weights to allow the natural descent and closing of the door pursuant to Bauart A1 standard.	4017004 103.95
	45° curve in stainless steel - Ø mm 150	4017005 115.50
	Flexible pipe to channel air - Ø mm 150 - 1,5 m	4017007 115.50
	Supplementary handle for Plasma	4019016 60.90
	Chimney handling kit 1 rubber 4 revolving wheels 4 threaded pipes for transport	4017008 489.30
	Comfort Air Kit Available in Slim Basic VF Basic VN	4011012 968.10 4008038N 661.50 4008036 177.45
	The hood kit should be completed by choosing 2 hot air outlets > WOOD_Accessories	



PLASMA 95 WOOD



PLASMA 95 WOOD

Model: PLASMA 95 WOOD

POWER kW	%	cm	kg	cm A x B x C
13,3	80,1	20	344	105,6 x 54 x 140,6

air	comfort air	comfort air	natural	easy switch	easy going			
-----	-------------	-------------	---------	-------------	------------	--	--	--

A ^{A+} / _G	4 STELLE D.M. 186	flamm 7*
--------------------------------	----------------------	----------

	CODE	£
PLASMA 95 WOOD	5017005	3362.44

	Passe-partout Painted black steel_303. It can be used as a minimal frame in the case of plasterboard cladding.	620216 294.76
	Additional weights kit Additional weights to allow the natural descent and closing of the door pursuant to Bauart A1 standard.	4017004 103.95
	45° curve in stainless steel - Ø mm 150	4017005 115.50
	Flexible pipe to channel air - Ø mm 150 - 1,5 m	4017007 115.50
	Supplementary handle for Plasma	4019016 60.90
	Chimney handling kit 1 rubber 4 revolving wheels 4 threaded pipes for transport	4017008 489.30
	Comfort Air Kit Available in Slim Basic VF Basic VN	4011012 968.10 4008038N 661.50 4008036 177.45
	The hood kit should be completed by choosing 2 hot air outlets > WOOD_Accessories	



PLASMA 85 WOOD



PLASMA 85 WOOD

Model: PLASMA 85 WOOD

POWER kW 13,3	 80,1	 20	 328	 cm A x B x C 95,6 x 54 x 156,6
 air	 comfort air	 natural	 easy switch	 easy going
 A	 4 STELLE D.M. 186			

	CODE	£
PLASMA 85 WOOD	5017010	3362.44

	Passe-partout Painted black steel_303. It can be used as a minimal frame in the case of plasterboard cladding.	4017013 294.76
	Additional weights kit Additional weights to allow the natural descent and closing of the door pursuant to Bauart A1 standard.	4017004 103.95
	45° curve in stainless steel - Ø mm 150	4017005 115.50
	Flexible pipe to channel air - Ø mm 150 - 1,5 m	4017007 115.50
	Supplementary handle for Plasma	4019016 60.90
	Chimney handling kit 1 rubber 4 revolving wheels 4 threaded pipes for transport	4017008 489.30
	Comfort Air Kit Available in Slim Basic VF Basic VN	4011012 968.10 4008038N 661.50 4008036 177.45
	The hood kit should be completed by choosing 2 hot air outlets > WOOD_Accessories	



PLASMA 75 WOOD



PLASMA 75 WOOD

Model: PLASMA 75 WOOD

POWER kW	%	cm	kg	cm A x B x C
12,5	80,3	20	312	84,6 x 54 x 156,6



	CODE	£
PLASMA 75 WOOD	5017012	2998.38

	Passe-partout Painted black steel_303. It can be used as a minimal frame in the case of plasterboard cladding.	6217004	284.59
	Additional weights kit Additional weights to allow the natural descent and closing of the door pursuant to Bauart A1 standard.	4017004	103.95
	45° curve in stainless steel - Ø mm 150	4017005	115.50
	Flexible pipe to channel air - Ø mm 150 - 1,5 m	4017007	115.50
	Supplementary handle for Plasma	4019016	60.90
	Chimney handling kit 1 rubber 4 revolving wheels 4 threaded pipes for transport	4017008	489.30
	Comfort Air Kit Available in Slim Basic VF Basic VN	4011012 4008038N 4008036	968.10 661.50 177.45
	The hood kit should be completed by choosing 2 hot air outlets > WOOD_Accessories		



PLASMA 95 DX/SX WOOD



PLASMA 95 DX/SX WOOD

Model: PLASMA 95 DX WOOD - PLASMA 95 SX WOOD

POWER kW	%	cm	kg	cm A x B x C
14,8	80,8%	20	370	103 x 59 x 168,1



	CODE	£
PLASMA 95DX WOOD	5018006	4413.95
PLASMA 95SX WOOD	5018011	4413.95

	Passe-partout RH (DX) Passe-partout LH (SX) Painted black steel_303. It can be used as a minimal frame in the case of plasterboard cladding.	4018019 4018020	284.59 355.74
	Additional weights kit Additional weights to allow the natural descent and closing of the door pursuant to Bauart A1 standard.	4018023	103.95
	45° curve in stainless steel - Ø mm 150	4017005	115.50
	Flexible pipe to channel air - Ø mm 150 - 1,5 m	4017007	115.50
	Supplementary handle for Plasma	4019016	60.90
	Chimney handling kit 1 rubber 4 revolving wheels 4 threaded pipes for transport	4017008	489.30
	Comfort Air Kit Available in Slim Basic VF Basic VN	4011012 4008038N 4008036	968.10 661.50 177.45
	The hood kit should be completed by choosing 2 hot air outlets > WOOD_Accessories		



PLASMA 75 DX/SX WOOD



PLASMA 75 DX/SX WOOD

Model: PLASMA 75 DX WOOD - PLASMA 75 SX WOOD

POWER kW 15,5	80,1	20	330	cm A x B x C 84,5 x 59 x 168,1
air	comfort air	natural	easy switch	easy going
	4 STELLE D.M. 186			

	CODE	£
PLASMA 75DX WOOD	5018005	4067.45
PLASMA 75SX WOOD	5018010	4067.45

	Passe-partout RH (DX) Passe-partout LH (SX) Painted black steel_303. It can be used as a minimal frame in the case of plasterboard cladding.	4018014 4018015	284.59 355.74
	Additional weights kit Additional weights to allow the natural descent and closing of the door pursuant to Bauart A1 standard.	4018018	103.95
	45° curve in stainless steel - Ø mm 150	4017005	115.50
	Flexible pipe to channel air - Ø mm 150 - 1,5 m	4017007	115.50
	Supplementary handle for Plasma	4019016	60.90
	Chimney handling kit 1 rubber 4 revolving wheels 4 threaded pipes for transport	4017008	489.30
	Comfort Air Kit Available in Slim Basic VF Basic VN	4011012 4008038N 4008036	968.10 661.50 177.45
	The hood kit should be completed by choosing 2 hot air outlets > WOOD_Accessories		



PLASMA 115B WOOD



PLASMA 115B WOOD

MODEL: PLASMA 115B WOOD

POWER kW 12,6	 77,6	 20	 334	 cm A x B x C 128 x 59,4 x 142

	CODE	£
PLASMA 115B WOOD	5017003	4441.67
Passe-partout Painted black steel_303. It can be used as a minimal frame in the case of plasterboard cladding.	620217	308.62
Additional weights kit Additional weights to allow the natural descent and closing of the door pursuant to Bauart A1 standard.	4017004	103.95
45° curve in stainless steel - Ø mm 150	4017005	115.50
Flexible pipe to channel air - Ø mm 150 - 1,5 m	4017007	115.50
Supplementary handle for Plasma	4019016	60.90
Chimney handling kit 1 rubber 4 revolving wheels 4 threaded pipes for transport	4017008	489.30
Comfort Air Kit Available in Slim Basic VF Basic VN	4011012 4008038N 4008036	968.10 661.50 177.45
>>>	The hood kit should be completed by choosing 2 hot air outlets > WOOD_Accessories	



PLASMA B95 WOOD



PLASMA B95 WOOD

Model: PLASMA B95 WOOD

POWER kW	%	cm	kg	cm A x B x C
18,6	77,2	20	298	105,6 x 59,4 x 142



4 STELLE
D.M. 186



	CODE	£
PLASMA B95 WOOD	5020005	3859,55

	Passe-partout Painted black steel_303. It can be used as a minimal frame in the case of plasterboard cladding.	620216	294.76
	Additional weights kit Additional weights to allow the natural descent and closing of the door pursuant to Bauart A1 standard.	4017004	103.95
	45° curve in stainless steel - Ø mm 150	4017005	115.50
	Flexible pipe to channel air - Ø mm 150 - 1,5 m	4017007	115.50
	Supplementary handle for Plasma	4019016	60.90
	Chimney handling kit 1 rubber 4 revolving wheels 4 threaded pipes for transport	4017008	489.30
	Comfort Air Kit Available in Slim Basic VF Basic VN	4011012 4008038N 4008036	968.10 661.50 177.45
	The hood kit should be completed by choosing 2 hot air outlets > WOOD_Accessories		



PLASMA 95T WOOD



PLASMA 95T WOOD

Model: PLASMA 95T WOOD

POWER kW	%	cm	kg	cm A x B x C
13,2	80,2	20	373	106 x 61,8 x 157,3



	CODE	£
PLASMA 95T WOOD	5018008	4449.06

	Passe-partout Painted black steel_303. It can be used as a minimal frame in the case of plasterboard cladding.	4018012	284.59
	Spacer Painted black steel_303 should be used to fill the gap between the glass-fronted fireplace and non-MCZ artisan fireplace.	4018013	122.85
	Additional weights kit Additional weights to allow the natural descent and closing of the door pursuant to Bauart A1 standard.	4018024	103.95
	45° curve in stainless steel - Ø mm 150	4017005	115.50
	Flexible pipe to channel air - Ø mm 150 - 1,5 m	4017007	115.50
	Supplementary handle for Plasma	4019016	60.90
	Chimney handling kit 1 rubber 4 revolving wheels 4 threaded pipes for transport	4017008	489.30
	Comfort Air Kit Available in Slim Basic VF Basic VN The hood kit should be completed by choosing 2 hot air outlets > WOOD_Accessories	4011012 4008038N 4008036	968.10 661.50 177.45



PLASMA T50 WOOD



PLASMA T50 WOOD

Model: PLASMA T50 WOOD

POWER kW	%	cm	kg	cm A x B x C
18,2	77,6	20	360	55,7 x 101,9 x 162,1

air	comfort air	comfort air natural	easy switch	easy going			
-----	-------------	---------------------	-------------	------------	--	--	--

			4 STELLE D.M. 186	
--	--	--	-----------------------------	--

		CODE	£
	PLASMA T50 WOOD	5019014	4631.09
	Passe-partout Painted black steel_303. It can be used as a minimal frame in the case of plasterboard cladding.	4018010	284.59
	Spacer Painted black steel_303 should be used to fill the gap between the glass-fronted fireplace and non-MCZ artisan fireplace.	4018011	122.85
	Additional weights kit Additional weights to allow the natural descent and closing of the door pursuant to Bauart A1 standard.	4018025	103.95
	45° curve in stainless steel - Ø mm 150	4017005	115.50
	Flexible pipe to channel air - Ø mm 150 - 1,5 m	4017007	115.50
	Supplementary handle for Plasma	4019016	60.90
	Chimney handling kit 1 rubber 4 revolving wheels 4 threaded pipes for transport	4017008	489.30
	Comfort Air Kit Available in Slim Basic VF Basic VN	4011012 4008038N 4008036	968.10 661.50 177.45
	The hood kit should be completed by choosing 2 hot air outlets > WOOD_Accessories		



VIVO 90 Q WOOD





VIVO 90Q WOOD







	CODE	£
VIVO 90Q WOOD	5020002	1903.44



	Four sided frame 50 mm steel frame	6309021	225.46
	Comfort Air Kit Available in Slim Basic VF Basic VN	4011012 4008038N 4008036	968.10 661.50 177.45
The hood kit should be completed by choosing 2 hot air outlets > WOOD_Accessories			

VIVO 90Q WOOD

Model: VIVO 90Q WOOD

POWER kW	 %	 cm	 kg	 cm A x B x C
11,6	85,1	20	135	88,7 x 45 x 54,7





VIVO 70Q WOOD







	CODE	£
VIVO 70Q WOOD	5020001	1751.90



	Four sided frame 50 mm steel frame	6309020	225.46
	Comfort Air Kit Available in Slim Basic VF Basic VN	4011012 4008038N 4008036	968.10 661.50 177.45
The hood kit should be completed by choosing 2 hot air outlets > WOOD_Accessories			

VIVO 70Q WOOD

Model: VIVO 70Q WOOD



POWER kW	 %	 cm	 kg	 cm A x B x C
11,6	85,1	20	125	71,7 x 45 x 62,2



QBOX 100 WOOD

	CODE	£
QBOX 100 WOOD	5023008	3012.24







	Four sided frame 25 mm steel frame	4023011	142.30
	Three sided frame 45 mm steel frame	4023010	122.90

IMPORTANT: QBOX 100 WOOD is fitted with standard ventilation kit, not compatible with the Comfort Air Basic and Slim kits.

QBOX 100 WOOD

Model: QBOX 100 WOOD



POWER kW	 %	 cm	 kg	 cm A x B x C
11,8	85,2	20	165	101 x 47 x 61



QBOX 80 WOOD

	CODE	£
QBOX 80 WOOD	5023010	2358.05















			
	Four sided frame 25 mm steel frame	4023007	137.68
	Three sided frame 45 mm steel frame	4023006	113.66

IMPORTANT: QBOX 80 WOOD is fitted with standard ventilation kit, not compatible with the Comfort Air Basic and Slim kits.

QBOX 80 WOOD

Model: QBOX 80S WOOD

POWER kW 9,5	 85,1	 15 cm	 138 kg	 cm A x B x C 81 x 47 x 61
 air	 comfort air	 natural	 easy switch	 easy going
 A ⁺ ↑ G	 4 STELLE D.M. 186	 CONTO TERMICO	 <i>flamme VERDE</i> 7*	

QBOX 70 WOOD

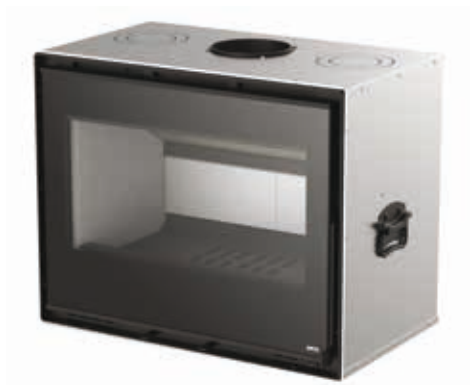

	CODE	£
QBOX 70 WOOD	5023005	2140.91

	Four sided frame 25 mm steel frame	4023005 133.06
	Three sided frame 45 mm steel frame	4023004 109.03

IMPORTANT: QBOX 70 WOOD is fitted with standard ventilation kit, not compatible with the Comfort Air Basic and Slim kits.

QBOX 70 WOOD

Model: QBOX 70 WOOD



POWER kW 8,8	 85,3	 15	 120	 cm A x B x C 72 x 42 x 55
---------------------------	----------	--------	---------	----------------------------------



QBOX 60 WOOD

	CODE	£
QBOX 60 WOOD	5023006	1865.56





			
	Four sided frame 25 mm steel frame	4023009	127.51
	Three sided frame 45 mm steel frame	4023008	104.42

IMPORTANT: QBOX 60 WOOD is fitted with standard ventilation kit, not compatible with the Comfort Air Basic and Slim kits.

QBOX 60 WOOD

Model: QBOX 60 WOOD

POWER kW 6,6	 85,1	 15 cm	 91 kg	 cm A x B x C 62 x 42 x 50
 air	 comfort air	 natural	 easy switch	 easy going
 A ⁺ ↑ G	 4 STELLE D.M. 186	 CONTO TERMICO	 Flamme VERTE 7*	

STONE CASE 60



STONE CASE



	CODE	£	
	STONE CASE 60 CUSTOM*	7124014	3214.05
	STONE CASE 60 MATERIA TORTORA 252 Materia Tortora	7124015	3503.85
	STONE CASE 60 MATERIA PIOMBO 253 Materia Piombo	7124016	3503.85
	STONE CASE 60 MATERIA CORTEN 251 Materia Corten	7124017	3503.85
	STONE CASE 70 CUSTOM*	7124018	3616.20
	STONE CASE 70 MATERIA TORTORA 252 Materia Tortora	7124019	3907.05
	STONE CASE 70 MATERIA PIOMBO 253 Materia Piombo	7124020	3907.05
	STONE CASE 70 MATERIA CORTEN 251 Materia Corten	7124021	3907.05

* Grès with a maximum thickness of 3.5 mm

STONE CASE 60 NEW

Model: STONE CASE 60

POWER kW 6,6	 % 85,1	 cm 15	 kg 150	 cm A x B x C 64,3 x 49,4 x 92,2

STONE CASE 70 NEW

Model: STONE CASE 70

POWER kW 8,8	 % 85,3	 cm 15	 kg 191	 cm A x B x C 74,1 x 49,4 x 98,2

STEEL CASE 70



STEEL CASE



	CODE	£
STEEL CASE 60	7124012	3150.00
STEEL CASE 70	7124013	3552.15

STEEL CASE 60

NEW

Model: STEEL CASE 60

POWER kW	%	cm	kg	cm A x B x C
6,6	85,1	15	156	63,7 x 49,4 x 92



4 STELLE
D.M. 186

CONTO
TERMICO

flamme
VERDE 7*

STEEL CASE 70

NEW

Model: STEEL CASE 70

POWER kW	%	cm	kg	cm A x B x C
8,8	85,3	15	193	73,5 x 49,4 x 97,9



4 STELLE
D.M. 186

CONTO
TERMICO

flamme
VERDE 7*

PELLET BOILERS

- 124 TECHNA SMARTCLEAN 21
- 125 TECHNA SMARTCLEAN 27
- 127 TECHNA SMARTCLEAN 32
- 128 PELLET LOADING AND STORAGE SYSTEMS
- 130 EASY TANK
- 132 HOPPER BOTTOM CONTAINERS
- 134 FLAT-BOTTOM CONTAINERS

TECHNA SMARTCLEAN 21



TECHNA SMARTCLEAN 21 NEW

Model: TECHNA SMARTCLEAN 21

POWER kW 19,4	POWER kW 20,9	 % 92,9/91,8	 kg 140	 l/min -	 h 33/126			
 l 61	 bar 2,5	 mm 80	 kg 236	 °C 94	 g/s 11,9			

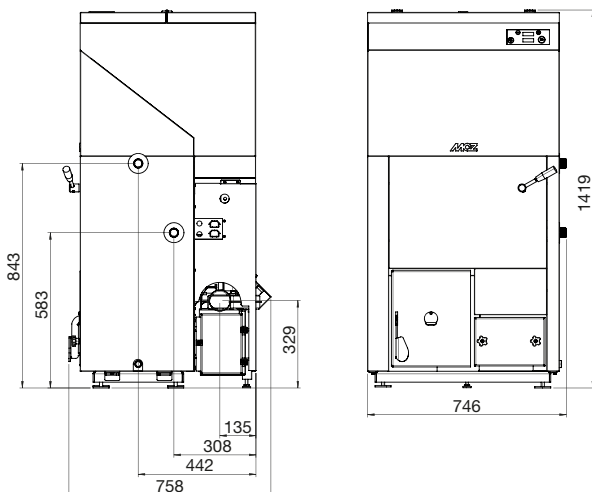

	CODE	£
TECHNA SMARTCLEAN 21	7324001	4764.38
Accessories		
	Wi-Fi wireless thermostat	40A24002 438.90
	Web - Wi-Fi interface	40A24003 300.30
	Pellet level sensor	40A17029 161.70
	NTC probe Temperature probe Cable length 1500 mm	4012062 31.19
	Hydraulic separator unit	40A24004 629.48
	Circulator kit with anti-condensation valve	40A24006 646.80
	F1 protective liquid	40A13018 83.16
	F3 cleaning liquid	40A13019 77.39
	F4 sealing liquid	40A13020 71.61



TECHNA SMARTCLEAN 27

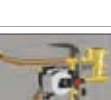

	CODE	£
TECHNA SMARTCLEAN 27	7324002	5154.19

Accessories		
	Wi-Fi wireless thermostat	40A24002 438.90
	Web - Wi-Fi interface	40A24003 300.30
	Pellet level sensor	40A17029 161.70
	NTC probe Temperature probe Cable length 1500 mm	4012062 31.19
	Hydraulic separator unit	40A24004 629.48
	Circulator kit with anti-condensation valve	40A24006 646.80
	F1 protective liquid F3 cleaning liquid F4 sealing liquid	40A13018 83.16 40A13019 77.39 40A13020 71.61

TECHNA SMARTCLEAN 27 NEW

Model: TECHNA SMARTCLEAN 27

POWER kW 25,2	POWER kW 27	 % 93,3/92,2	 kg 180	 l/min -	 h 33/118			
 l 74	 bar 2,5	 mm 80	 kg 267	 °C 97	 g/s 15,9			



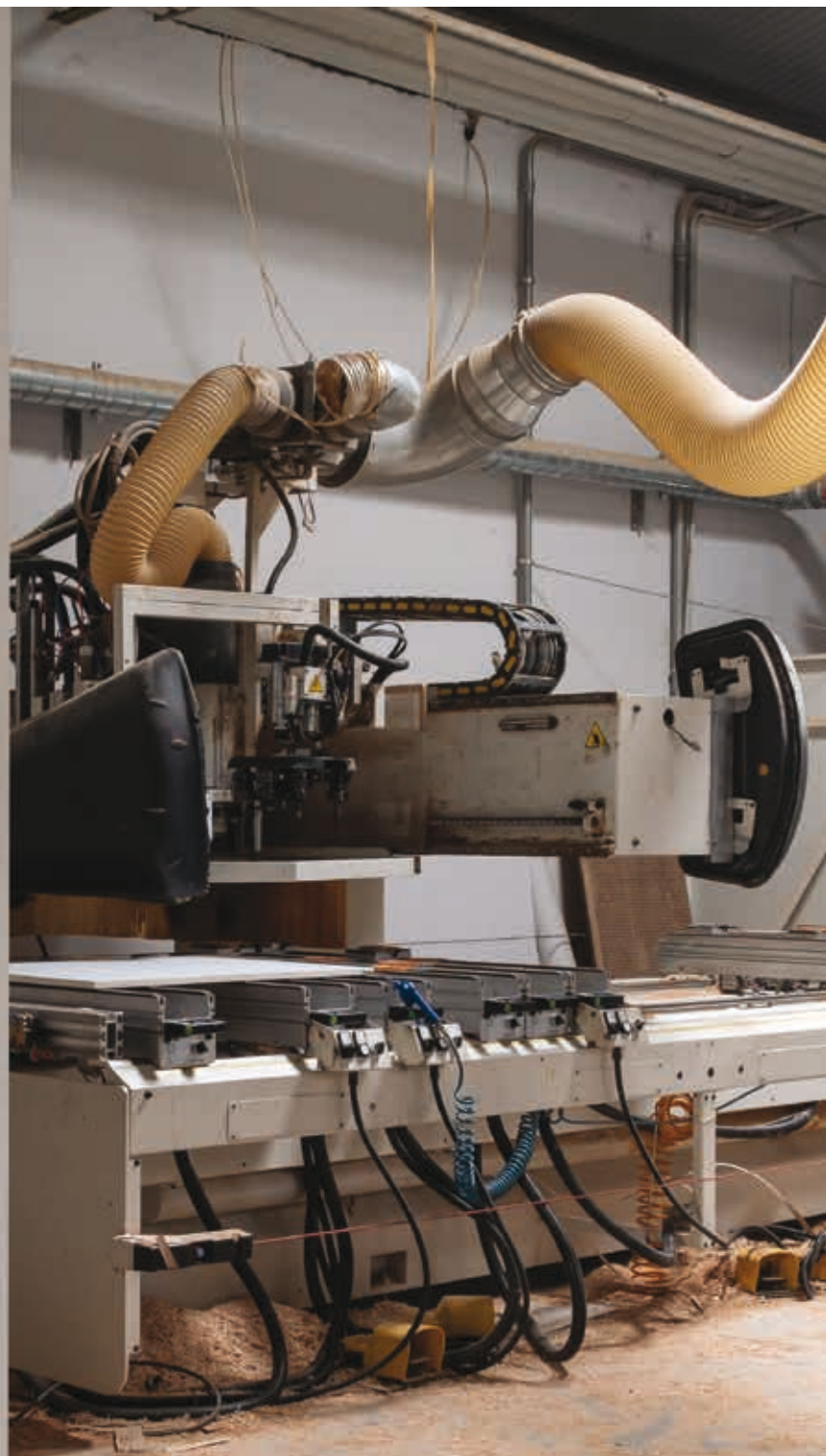

TECHNA SMARTCLEAN 32



	CODE	£
TECHNA SMARTCLEAN 32	7324003	5500.69

Accessories		
	Wi-Fi wireless thermostat	438.90
	Web - Wi-Fi interface	300.30
	Pellet level sensor	161.70
	NTC probe Temperature probe Cable length 1500 mm	31.19
	Hydraulic separator unit	629.48
	Circulator kit with anti-condensation valve	646.80
	F1 protective liquid	83.16
	F3 cleaning liquid	77.39
	F4 sealing liquid	71.61

TECHNA SMARTCLEAN 32 NEW

Model: TECHNA SMARTCLEAN 32

POWER kW 29,8	POWER kW 31,8	 % 93,7/92,6	 kg 180	 l/min -	 h 28/97
 l 74	 bar 2,5	 mm 80	 kg 290	 °C 100	 g/s 19,1



PELLET LOADING AND STORAGE SYSTEMS



CONNECTION KIT

PELLET LOADING SYSTEMS

CONTROL KIT

FITTING PLATE

EASY TANK

JOINT FITTING PLATE

LINK-CONNECTION KIT - 12 M

VACUUM-SUCTION SYSTEM

JOINT FITTING PLATE

LINK-CONNECTION KIT - 12 M

VACUUM-SUCTION SYSTEM

JOINT FITTING PLATE

LOADING FEED SCREW MINI-FEED UP TO 25KW

MAXI-FEED LOADING FEED SCREW OVER 25KW

CONTROL KIT

EASY TANK

Compatible with all pellet boilers in the Techna range.

To complete a system, select from each group the component and any specific accessories required by the system.

PELLET STORAGE HOPPER > EASY TANK

PELLET STORAGE HOPPER 200 KG + FUEL RELEASE FEEDER + HOSES

40A20001

1634.85

The kit includes:

- EasyTank pellet storage hopper with integrated extractor
- Fuel release feeder
- 2 x 2.5 m hoses "IN" and "OUT"

PELLET STORAGE HOPPER



FITTING PLATE

FITTING PLATE > JOINT/BOILER

JOINT fitting plate to connect VACUUM on TECHNA

40A24005

173.25



HOPPER BOTTOM CONTAINERS

Compatible with all pellet boilers in the Techna range.

To complete a system, select from each group the component and any specific accessories required by the system.

PELLET STORAGE HOPPER



PELLET STORAGE HOPPER > BASIC BOX

300kg remote tank - BASIC BOX 300
Dimensions (LxPxH) 972x577x1404 mm

40A13025

834.75

PELLET LOADING SYSTEMS



PELLET LOADING SYSTEMS > FEED SCREW MINI-FEED

Loading feed screw Mini-FEED up to 25 kW

40A13026

626.85



PELLET LOADING SYSTEMS > FEED SCREW MAXI-FEED

Maxi-FEED loading feed screw over 25 kW

40A13027

1113.00

CONTROL KIT



CONTROL KIT

ELECTRO feed screw control unit + 2 pellet level sensors (for remote hopper and boiler hopper) LEV + hopper bracket

40A17031

657.30

HOPPER BOTTOM CONTAINERS

Compatible with all pellet boilers in the Selecta and Techna range.

To complete a system, select from each group the component and any specific accessories required by the system.



PELLET STORAGE HOPPER > BIG-HOP HOPPER BOTTOM

Big-HOP 34 (min 2.4 t - max 3.4 t)	mm 2000 x 2000 x H 2000/2500	40A17002	5381.25
Big-HOP 55 (min 4.0 t - max 5.5 t)	mm 2500 x 2500 x H 2000/2500	40A17003	6481.65
Big-HOP 76 (min 5.2 t - max 7.6 t)	mm 3000 x 3000 x H 2000/2500	40A17004	8139.60

To be combined with adapter 40A17011

PELLET STORAGE HOPPER > PICKUP SYSTEMS > ADAPTER FOR SUCTION UNIT ADAP

Adapter for suction unit ADAP Crucial for Big-HOP use		40A17011	272.58
--	--	----------	--------



PELLET STORAGE HOPPER > MIDI-HOP 430 KG HOPPER BOTTOM

Midi-HOP 430 kg hopper bottom 990x990 x H 1140 mm - 50,7 kg		40A17006	1757.70
--	--	----------	---------



PELLET STORAGE HOPPER > DEDICATED ACCESSORIES > DOUBLE-MIDI H 600 MM +350 KG LIFTING MODULE

DOUBLE-midi h 600 mm +350 kg lifting module. This element is used in 40A17006 and 40A17008 storage containers to increase the capacity by 350 kg (optional)		40A17010	395.85
--	--	----------	--------



PELLET STORAGE HOPPER > DEDICATED ACCESSORIES > MIDI-COVER

Midi-COVER. This cover is used in 40A17006 and 40A17008 storage containers (optional)		40A17024	225.75
--	--	----------	--------



PELLET STORAGE HOPPER > DEDICATED ACCESSORIES > BRACK FASTENING BRACKETS

Wall fastening brackets (pair) BRACK for midi tanks 40A17006 and 40A17008 (optional)

40A17022

77.70

**EXTRACTOR > DOWN**

Horizontal extractor for suction on hopper tanks MIDI-HOP

40A17012

273.00

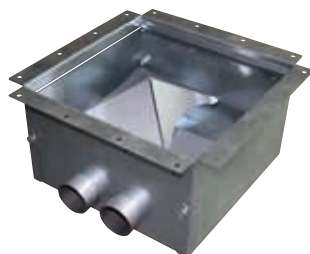
**EXTRACTOR > EXTRA-DOWN**

Horizontal extractor with feed screw for suction on hopper tanks. This kit is used to make it easier to remove pellets in difficult circumstances.

40A17013

2178.75

**CONNECTION KIT > LINK**

12 m + 12 m of copper-plated spiral wound pipe, 4 straps.

40A17030

782.25

**PELLET LOADING SYSTEMS > SUCTION UNITS > VACUUM SUCTION SYSTEM**

VACUUM suction system

40A17015

1562.40

Fuel loading

Ø 50 mm

Air outlet

Ø 50 mm

Motor power

1.42 kW

Maximum air inlet

216 m³/h

Maximum metering device capacity

5,2 l



FLAT-BOTTOM CONTAINERS - 350 TO 700 KG

Compatible with all pellet boilers in the Selecta and Techna range.

To complete a system, select from each group the component and any specific accessories required by the system.

PELLET STORAGE HOPPER

PELLET STORAGE HOPPER > MIDI-TANK 350 KG FLAT BOTTOM

Midi-TANK 350kg flat bottom

40A17008

929.78



PELLET STORAGE HOPPER > DEDICATED ACCESSORIES > DOUBLE-MIDI H 600 MM +350 KG LIFTING MODULE

DOUBLE-midi h 600 mm +350 kg lifting module.

This element is used in 40A17006 and 40A17008 storage containers to increase the capacity by 350 kg (optional)

40A17010

398.17



PELLET STORAGE HOPPER > DEDICATED ACCESSORIES > MIDI-COVER

Midi-COVER.

This cover is used in 40A17006 and 40A17008 storage containers (optional)

40A17024

225.75



PELLET STORAGE HOPPER > DEDICATED ACCESSORIES > BRACK FASTENING BRACKETS

Wall fastening brackets (pair) BRACK for midi tanks 40A17006 and 40A17008 (optional)

40A17022

77.70



EXTRACTOR > TURTLE

Vertical extractor for suction on flat bottom tanks MIDI-TANK or additional horizontal tank (this can be chosen by the client – not necessarily a one)

40A17014

1253.70



EXTRACTOR

EXTRACTOR

**EXTRACTOR > DEDICATED ACCESSORIES > LIFTING KIT "LIFT"**

Lifting kit for LIFT vertical extractor.

Kit to lift the TURTLE extractor when there are no more pellets (optional)

40A17025

159.39

CONNECTION KIT

**CONNECTION KIT > LINK**

12 m + 12 m of copper-plated spiral wound pipe, 4 straps.

40A17030

782.25

PELLET LOADING SYSTEMS

**PELLET LOADING SYSTEMS > SUCTION UNITS > VACUUM SUCTION SYSTEM**

VACUUM suction system

Fuel loading

Ø 50 mm

Air outlet

Ø 50 mm

Motor power**1.42 kW**

Maximum air inlet

216 m³/h

Maximum metering device capacity

5,2 l

40A17015

1562.40

FITTING PLATE

**FITTING PLATE > JOINT/BOILER**

JOINT fitting plate to connect VACUUM on TECHNIA

40A24005

173.25

JOINT fitting plate to connect VACUUM on SELECTA

40A17020

161.70

PELLET_Accessories

138 GENERAL ACCESSORIES

141 COMFORT AIR STOVES ACCESSORIES



LINEAR PIPE

Painted pipe, 25/50/100 cm, with silicone gasket.

L= 25 cm - ø cm 8	4022005	31.19
L= 50 cm - ø cm 8	4022006	36.96
L= 100 cm - ø cm 8	4022007	48.51



90° CURVE

Painted curve with silicone gasket.

ø cm 8	4022008	42.74
--------	---------	-------



90° CURVE WITH INSPECTION HOLE

Painted curve with silicone gasket.

ø cm 8	4022010	48.51
--------	---------	-------



90° CURVE GASKETS WITH HOLE INSPECTION

5 pc. package

	4012022	25.41
--	---------	-------



45° CURVE

Painted curve with silicone gasket.

ø cm 8	4022009	42.74
--------	---------	-------



T-UNION

Condensate/ash collection painted tee union with inspection cap and silicone gasket.

ø cm 8	4022004	55.44
--------	---------	-------

FEMALE-FEMALE TEE FITTING

Painted tee union with silicone gasket.

ø cm 8

4022012

48.51



DRAUGHT ADJUSTOR

Pipe with silicone gasket fitted with device to adjust excessive draught.

ø cm 8

4010002

361.52



WALL COUPLING

Painted wall coupling with silicone gasket.

ø cm 8

4022011

31.19



F/F-UNION

Painted pipe with silicone gaskets.

ø cm 8/8
ø cm 10/10

4013010
4013009

42.74
48.51



WINDPROOF CAP

Stainless steel windproof cap for wall discharge.

ø cm 8

40160156

25.41



WALL FLANGE

Painted wall flange.

ø cm 8

40160466

18.48



PIPE CLIP

Pipe support clip for wall fastening.

ø cm 8

40120968

18.48



SILICONE GASKET

for 8 cm pellet stove pipes.

5-pack.

40120969

25.41



FLOOR PROTECTION

Available in charcoal painted metal and in tempered glass (photo)

Standard version: 90x100 cm (width x depth)

Slim pellet stove version: 95x57 cm (width x depth)

Sheet thickness: 2 mm

Glass thickness: 6 mm

Standard version - metal

40140139

152.46

Standard version - glass

40170147

207.90

Slim version - metal

4011051

135.14

Slim version - glass

4011050

183.65

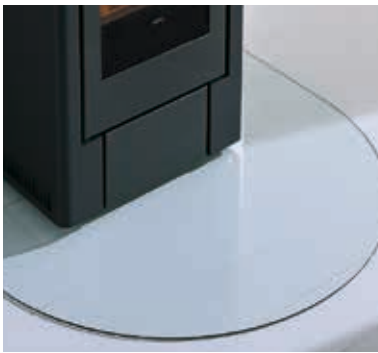

TOUCH-UP PAINT

Water-based silicone spray paint
Check on the unit for the code to use.

Black - 400 ml

4017011

36.96

Black touch-up color for C16
powder paints 400 ml

4020012

61.22



CLEANING KIT AND STOVE MAINTENANCE CASE

Contains:

- Hexagonal wrench
- Set of brushes and paintbrushes (3 pieces)
- Complete set of inner gaskets and fire door (5 kits)
- Glass cleaning spray
- Bolts and screws and washer
- High temperature silicone
- Manual

4009023

281.82



MAINTENANCE CASE GASKETS REFILL KIT

Complete set of inner gaskets and fire door (5 kits)

4012027

166.32





FLIP HOT AIR OUTLET

Silk screen printed glass flipping air outlet to direct the flow of hot air. Metal support. Complete with two lamps and air humidifier.

White - cm 21,6x24,6

4012017

313.01

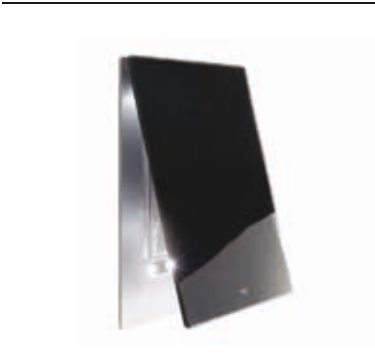

GHOST HOT AIR OUTLET

Silk screen printed glass flipping air outlet. Brushed steel support. Complete with one lamp and air humidifier.

White glass - cm 22,5x22,5

4012020

330.33

Black glass - cm 22,5x22,5

4012021

330.33



MINIMAL HOT AIR OUTLET

Backlit metal air vent, can be painted like back wall. Complete with two lamps.

Cm 21,5x21,5

4017009

256.41



SOFT HOT AIR OUTLET

Backlit ceramic air vent. Complete with two lamps.

Cm 25x25

4017010

281.82



MULTI 12 HOT AIR OUTLET

Kit contents:
 One (1) 120x120 mm multi-directional hot air outlet
 One (1) frame
 One (1) Ø 60 flange
 One (1) Ø 60 plug
 Four (4) screws
 One (1) clamp

Cm 12x12

4009010

42.74



Ø 60 mm STRAIGHT UNION

Ducting connection union.
 Kit contents:
 One (1) Ø 60 straight union
 Two (2) clamps

4009008

11.55





Ø 60 mm "Y" UNION

Union to divert the flow of hot air in 2 ducts.
 Kit contents:
 One (1) Y union
 Three (3) clamps

4009009

25.41



Ø 60 mm 90° CURVE

Kit contents:
 One (1) 90° union
 Three (2) clamps

4009011

18.48



FLEX PIPE Ø 60 L = 8 m



4009017

61.22



FLEX PIPE Ø 60 L = 1.5 m



4009003

31.19



INSULATED FLEX PIPE

Ø 60 mm interior/110 mm exterior
 L= 3 m



4013005

55.44



FLEXIBLE PIPE

Ø 100 mm - L=1.5 m
 Ø 100 mm insulated - L=10 m insulated



40160049

25.41

4008049

214.83





Ø 60 mm FAN/PIPE UNION

Union for ducting with Ø 60 mm pipe.

Kit contents:

One (1) Ø 60 fan/pipe union

Two (2) screws

One (1) clamp

4009007

31.19

> EGO, STAR, CLUB, SUITE, MUSA 1.0

> TOBA - PHILO



Ø 60 mm STRAIGHT UNION - 150 mm

Ducting connection union.

To be purchased in combination with code 4009008

4015013

31.19

> EGO, STAR, CLUB, SUITE, MUSA 2.0

> KLIN - TILDA - AIKE - STREAM



Ø 80 mm FAN/PIPE UNION

Union for ducting with Ø 80 mm pipe.

Kit contents:

One (1) Ø 80 fan/pipe union

Two (2) screws

One (1) clamp

4009013

31.19

> EGO, STAR, CLUB, SUITE, MUSA 1.0

> TOBA - PHILO



Ø 60/80 mm PIPE ADAPTER

4014008

25.41



WOOD_Accessories

146 COMFORT AIR SLIM

150 COMFORT AIR BASIC



SLIM FV VENTILATION KIT

Ventilation kit for standard connection with hot air outlets positioned in the hood or remotely and motor positioned freely between the glass-fronted fireplace and the hot air outlet. The hood kit should be completed by choosing 2 hot air outlets.

Complete kit

4011012

967.89

THE KIT INCLUDES:

FAN

Complete with housing and inspection hatch
(x2)



REMOTE CONTROL

Complete with electronic control unit
(x1)



FLEXIBLE PIPE

Ø 100 mm - L=1.5 m
(x2)



FLEXIBLE PIPE

Ø 60 mm - L=1.5 m
(x2)



FLANGE Ø 100

Ø 100 mm
(x2)



CLAMPS

(x8)



FLIP VENTILATION OUTLET

Complete with two lamps and air humidifier.

White glass/1 pc.

4012017

298,1



GHOST VENTILATION OUTLET

Complete with one lamp and air humidifier.

White/1 pc.

4012020

330.33

Black/1 pc.

4012021

330.33



MINIMAL VENTILATION OUTLET

Backlit metal air vent, can be painted like back wall.

4017009

256.41



SOFT VENTILATION OUTLET

Backlit ceramic air vent.

4017010

281.82



MULTI 12 VENTILATION OUTLET

1 pc.

4009010

42.74



**FLIP VENTILATION OUTLET**

Silk screen printed glass flipping air outlet to direct the flow of hot air.
Metal support. Complete with two lamps and air humidifier.

White glass

4012017

313.01**GHOST VENTILATION OUTLET**

Silk screen printed glass flipping air outlet. Brushed steel support.
Complete with one lamp and air humidifier.

White glass

4012020

330.33

Black glass

4012021

330.33**MINIMAL VENTILATION OUTLET**

Backlit metal air vent, can be painted like back wall.

4017009

256.41**SOFT VENTILATION OUTLET**

Backlit ceramic air vent.

4017010

281.82**MULTI 12 VENTILATION OUTLET**

1 pc.

4009010

42.74**REMOTE CONTROL**

Complete with electronic control unit.

1 pc.

4011006

256.41**FAN**

Complete with housing and inspection hatch.

1 pc.

4011008

313.01**FLEXIBLE PIPE**

Ø 100 mm - L=1.5 m

1 pc.

40160049

25.41

Ø 100 mm insulated - L=10 m

1 pc.

4008049

214.83**FLEXIBLE PIPE**

Ø 60 mm - L=3 m insulated

1 pc.

4013005

55.44

Ø 60 mm - L=1.5 m

1 pc.

4009003

31.19**FLANGE Ø 100**

Ø 100 mm

1 pc.

4008047





18.48**FLANGE Ø 60**

Ø 60 mm

1 pc.

4011011

11.55

	Ø 60 STRAIGHT UNION	Ø 60 mm	1 pc.	4009008	11.55
	PIPE CLAMPS	Ø 60/170 mm	1 pc.	4008043	11.55
	BLADE VENTILATION OUTLET	Metal air outlet 99x6,1 cm	White	4020009	55.44
		Metal air outlet 60x6,7 cm	White	4012066	31.19
	LINE VENTILATION OUTLET	Metal air outlet 99x7,3 cm	White	4020010	98.18
	BIG VENTILATION OUTLET	Metal air outlet 51,6x18,5 cm	White	4011018	61.22

GHOST



FLIP



MINIMAL



SOFT



VN HOOD KIT (natural ventilation)

Ventilation kit for standard connection with outlets positioned in the hood above the fireplace. The kit is completed by choosing 2 outlets (mono, bi or multidirectional).

Complete kit

4008036

177.87



THE KIT INCLUDES:

VN DUCT FRAME

(x2)



FLEXIBLE PIPE

ø 150 mm - L=1.5 m

(x2)



FLANGE

ø 150 mm

(x2)



PIPE CLAMP

ø 60-170 mm

(x4)



FASTENING BRACKET ASSEMBLY

(x2)



MONO 20 > MONO-DIRECTIONAL AIR OUTLET WITH HUMIDIFIER

*The mono-directional air outlet with light code 4008023 must be installed on duct frame code 4008046

Without light

4008021

135.14

With light*

4008023

313.01



BI 20 > BI-DIRECTIONAL AIR OUTLET

4008024

115.50



MULTI 20 > MULTI-DIRECTIONAL AIR OUTLET

4008025

42.74



FV HOOD KIT (forced ventilation)

Ventilation kit for standard connection with outlets positioned in the hood above the fireplace. The kit is completed by choosing 2 outlets (mono, bi or multidirectional).

Complete kit

4008038N

661.82



THE KIT INCLUDES:

FAN ASSEMBLY

(x2)



CONTROL UNIT

Complete with probe and power supply cable

(x1)



FLEXIBLE PIPE

ø 100 mm - L=1.5 m

(x2)



FLANGE

ø 100 mm

(x2)



PIPE CLAMP

Ø 60/170 mm

(x4)



FASTENING BRACKET ASSEMBLY

(x2)



MONO 20 > MONO-DIRECTIONAL AIR OUTLET WITH HUMIDIFIER

Without light

4008021

135.14

With light

4008023

313.01



BI 20 > BI-DIRECTIONAL AIR OUTLET

4008024

105.00



MULTI 20 > MULTI-DIRECTIONAL AIR OUTLET

4008025

42.74

WHEN TO USE THE INDIVIDUAL NV and FV ACCESSORIES.

The 2 hood kits described in the previous two pages accommodate standard connections with air outlets located in the hood, above the glass-fronted fireplace.

For other types of solutions, the use of the individual NV and FV accessories described on these two pages is required.



MONO 20 > MONO-DIRECTIONAL AIR OUTLET WITH HUMIDIFIER

Warning: the mono-direc. air outlet with light code 4008023 must be installed on duct frame code 4008046 (as can be seen in the photo)

Without light
With light

4008021
4008023

135.14
313.01



BI 20 > BI-DIRECTIONAL AIR OUTLET

Warning: the air outlet must be installed on duct frame code 4008044 (as can be seen in the photo)

4008024

115.50



MULTI 20 > MULTI-DIRECTIONAL AIR OUTLET

Warning: the air outlet must be installed on duct frame code 4008044 (as can be seen in the photo)

4008025

42.74



VN DUCT FRAME + BRACKET

4008044

61.22



NV DUCT FRAME WITH LIGHT + BRACKET

4008046

135.14



FLEXIBLE PIPE

ø 150 mm - L=1.5 m

40160051

31.19



FLANGE

ø 150 mm for NV

40120167

11.55



PIPE CLAMP

ø 60-170 mm

4008043

11.55



BASIC > VENTILATION GRILLE

99x5,2 cm

4008040

36.96



BASIC FILTER > FILTERED AIR OUTLET

53,5x16,5 cm

4008039

135.14



MONO 20 > MONO-DIRECTIONAL AIR OUTLET WITH HUMIDIFIER

Without light	4008021	135.14
With light	4008023	313.01



BI 20 > BI-DIRECTIONAL AIR OUTLET

	4008024	115.50
--	---------	--------



MULTI 20 > MULTI-DIRECTIONAL AIR OUTLET

	4008025	42.74
--	---------	-------



FAN ASSEMBLY + BRACKET

	4008050	220.61
--	---------	--------



CONTROL UNIT

Complete with probe and power supply cable - can control up to 2 motors.

	4008026N	172.10
--	----------	--------



FLEXIBLE PIPE

ø 100 mm - L=1.5 m	40160049	25.41
ø 100 mm insulated - L=10 m insulated	4008049	214.83



FLANGE

ø 100 mm for FV

	4008047	18.48
--	---------	-------



PIPE CLAMP

ø 60-170 mm

	4008043	11.55
--	---------	-------



RECESSED BOX

	4008051	72.45
--	---------	-------



BASIC > VENTILATION GRILLE

99x5,2 cm	4008040	36.96
-----------	---------	-------



BASIC FILTER > FILTERED AIR OUTLET

53,5x16,5 cm	4008039	135.14
--------------	---------	--------

WHEN TO USE THE SINGLE ACCESSORIES - EXAMPLE

The two hood kits accommodate standard connections with air outlets located above the glass-fronted fireplace. For other types of solutions, the use of NV and FV individual accessories is required.

For example, to duct air to a distance of 6 m, with two forced ventilation air outlets, the following accessories are required:

	<p>MONO/BI/MULTI-DIRECTIONAL AIR OUTLET</p>	<p>As desired.</p> <table border="1"> <tbody> <tr> <td>4008021</td> <td>135.14</td> </tr> <tr> <td>4008023</td> <td>313.01</td> </tr> <tr> <td>4008024</td> <td>115.50</td> </tr> <tr> <td>4008025</td> <td>42.74</td> </tr> </tbody> </table>	4008021	135.14	4008023	313.01	4008024	115.50	4008025	42.74
4008021	135.14									
4008023	313.01									
4008024	115.50									
4008025	42.74									
	<p>FAN ASSEMBLY + BRACKET</p>	<table border="1"> <tbody> <tr> <td>4008050</td> <td>220.61</td> </tr> </tbody> </table>	4008050	220.61						
4008050	220.61									
	<p>CONTROL UNIT</p>	<p>Complete with probe and power supply cable - can control up to 2 motors.</p> <table border="1"> <tbody> <tr> <td>4008026N</td> <td>172.10</td> </tr> </tbody> </table>	4008026N	172.10						
4008026N	172.10									
	<p>FLEXIBLE PIPE</p>	<table border="1"> <tbody> <tr> <td>ø 100 mm - L=1.5 m</td> <td>40160049</td> <td>25.41</td> </tr> <tr> <td>ø 100 mm insulated - L=10 m insulated</td> <td>4008049</td> <td>214.83</td> </tr> </tbody> </table>	ø 100 mm - L=1.5 m	40160049	25.41	ø 100 mm insulated - L=10 m insulated	4008049	214.83		
ø 100 mm - L=1.5 m	40160049	25.41								
ø 100 mm insulated - L=10 m insulated	4008049	214.83								
	<p>FLANGE</p>	<p>ø 100 mm for FV</p> <table border="1"> <tbody> <tr> <td>4008047</td> <td>18.48</td> </tr> </tbody> </table>	4008047	18.48						
4008047	18.48									
	<p>PIPE CLAMP</p>	<p>ø 60-170 mm</p> <table border="1"> <tbody> <tr> <td>4008043</td> <td>11.55</td> </tr> </tbody> </table>	4008043	11.55						
4008043	11.55									
<p>IT IS ALSO POSSIBLE TO ADD:</p>										
	<p>RECESSED BOX</p>	<p>Contains and protects the fan when it is to be recessed in a stone or brick wall.</p> <table border="1"> <tbody> <tr> <td>4008051</td> <td>72.45</td> </tr> </tbody> </table>	4008051	72.45						
4008051	72.45									
	<p>BASIC > VENTILATION GRILLE</p>	<p>For convection hot air inlet/outlet, instead of normal grilles.</p> <table border="1"> <tbody> <tr> <td>99x5,2 cm</td> <td>4008040</td> <td>36.96</td> </tr> </tbody> </table>	99x5,2 cm	4008040	36.96					
99x5,2 cm	4008040	36.96								
	<p>BASIC FILTER > FILTERED AIR OUTLET</p>	<p>Allows filtering and purification of the inlet air.</p> <table border="1"> <tbody> <tr> <td>53,5x16,5 cm</td> <td>4008039</td> <td>135.14</td> </tr> </tbody> </table>	53,5x16,5 cm	4008039	135.14					
53,5x16,5 cm	4008039	135.14								





HOT AIR OUTLET KIT

One (1) adjustable nozzle, ø 15 cm 20x20 cm
 One (1) flexible aluminium pipe, ø 15 cm, L = 150 cm
 One (1) connection flange, ø 15 cm
 Two (2) clamps

White nozzle	40160067	93.5
Brass coated nozzle	40160072	120.12

>PLASMA >FORMA >VIVO



DUAL HOT AIR OUTLET KIT WITH LARGE NOZZLE

One (1) large nozzle with unions ø 15 cm - 50x20 cm
 Two (2) flexible aluminium pipes, ø 15 cm, L = 150 cm
 Four (4) clamps
 Two (2) flange unions ø 15 cm

White nozzle	40160073	189.42
--------------	----------	--------

>PLASMA >FORMA >VIVO



SQUARE NOZZLE WITH CAP AND UNION Ø 15 cm

cm 20x20

White nozzle	40160007	85.47
--------------	----------	-------

>PLASMA >FORMA >VIVO



ADJUSTABLE HOOD VENTILATION OUTLET WITH CAP

cm 25x10

White nozzle	40160001	85.47
Brass coated nozzle	40160002	85.47

>PLASMA >FORMA >BOXTHERM



EXTRA-FLEXIBLE ALUMINIUM AIR SUCTION PIPE

10 m - Maximum operating temperature 140 °C.

Ø cm 15	40160441	140.91
Ø cm 10	40160440	109.73

>PLASMA >FORMA >VIVO >BOXTHERM



FLEXIBLE ALUMINIUM PIPE FOR HOT AIR DUCTING

1.5 m

Ø cm 15	40160051	31.19
---------	----------	-------

>PLASMA >FORMA

FLANGE

For connecting pipes to the glass-fronted fireplace.

Ø cm 10
Ø cm 15*

40120165
40120167

11.55
11.55



>PLASMA >FORMA >BOXTHERM

CERAMIC FIBRE MAT

Pack containing 9.37 m² of ceramic fibre mat

Roll width 0.63 m. 40180129

284.59



>PLASMA >FORMA >VIVO >BOXTHERM

STIFF INSULATION PANEL

100x61 cm, thickness 2.5 cm.

40180039

146.69



>PLASMA >FORMA >VIVO >BOXTHERM

TOUCH-UP PAINT

Water-based silicone spray paint - 400 ml

Black

4017011

36.96

Black touch-up color for C16
powder paints 400 ml

4020012

61.22



>PLASMA >FORMA >VIVO >BOXTHERM

GLASS SPRAY CLEANER

Product for cleaning glass-fronted fireplace and stove glass surfaces.

Minimum pack 12 pcs.

40180012

221.76

Contents 0.79 l. per bottle

Pack of 12 bottles.







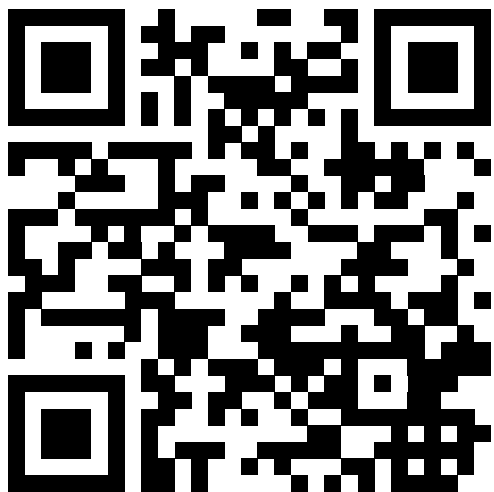

DEALER

MCZ

www.mcz-pelletstoves.co.uk